

SIEMENS

Be inspired

Gigaset
SL 100
150
DECT



The handset at a glance

Reception strength

Talk key

- ◆ Answer a call
- ◆ Initiate dialling
- ◆ Switch from handsfree to "earpiece" mode

Control key

Opens the menu, directory, voice-activated dialling. Navigation in the input field

Handsfree key

- ◆ Switch from "earpiece" to handsfree mode
- ◆ Lights up: Handsfree is activated
- ◆ Flashes: incoming call, automatic last number redial

Open directory

Key 1

Select Answering machine (SL 150 only)/network mailbox

Star key

- ◆ Ringer on/off (press for approx. 2 seconds)
- ◆ Toggles between upper/lower case and digits

Recall key

Insert a dial pause (hold key down)

Display (display screen)

Charge status

☺ flat 🔋 fully charged
 ☺ flashes: battery is almost flat or is charging

Current functions and display keys

The display keys give you access to the functions shown in the display.

End call key, On/Off key

- ◆ End call
- ◆ Cancel function
- ◆ One menu level back (short press)
- ◆ Back to idle status (press for approx. 1 second)
- ◆ Handset on/off (press for approx. 2 seconds)

Message key

- ◆ Accesses the lists of text messages, network mailbox, calls list/answering machine (SL 150 only),
- ◆ Flashes: new SMS, messages, calls

Hash key

Keypad lock on/off (press for approx. 1 second)

Speed dial list key

Open the speed dial list (short press)

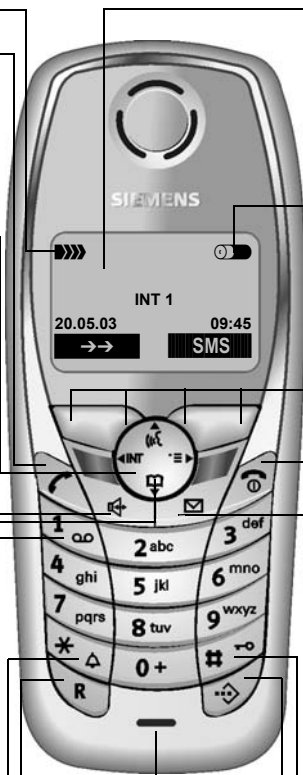

Microphone

Socket for headset and PC interface

Contents

The handset at a glance	1
Safety precautions	6
Preparing to use your phone	7
Installing the base station	7
Connecting the base station	8
Preparing to use the handset	9
Attaching the belt clip	11
Activating/deactivating the handset	11
Activating/deactivating the keypad lock	11
Operating the telephone, menu guidance	12
Keys	12
Correcting wrong input	13
Idle status	14
Menu operation, with "Handsfree Volume setting" as an example	14
Date and Time	15
Setting the date and time	15
Setting the alarm clock	15
Setting an appointment	16
Viewing missed appointments, anniversaries	17
Making calls	18
Making external calls and ending a call	18
Answering a call	18
Calling Line Identification	18
Handsfree	20
Muting	20
Using the directory and other lists	21
Directory and speed dial list	21
Managing entries in the directory and speed dial list	23
Voice-activated dialling	26
Last number redial list	28
Email directory	29
Display available memory	30
Opening lists with the message key	31

SMS (Text Messages)	35
General	35
Before you can send and receive text messages	36
Sending and receiving text messages	36
Text message sending and the draft message list	38
Sending a text message to an email address	40
Receiving text messages and incoming message list	43
Using several text message mailboxes	47
Notification by SMS	50
Using new ringer tones and screensavers for handsets	51
Text messages to a PABX	52
Errors when sending and receiving a text message	53
Using the answering machine in the SL 150	
Base station	55
Operating the answering machine via the handset	55
Recording memos	62
Operating the answering machine with voice prompts	63
Operating the answering machine while you are away from home (remote operation)	64
Setting the answering machine of the SL 150	
Base station	66
Ring delay and charge saving function for remote operation	66
Setting the recording time and recording quality	66
Activating/deactivating call screening	67
Resetting fast access on the answering machine	67
Using the network mailbox	68
Configuring the network mailbox for fast access	68
Viewing a message from the network mailbox	68
Registering and de-registering handsets	69
Manual registration: Gigaset SL 1 to Gigaset SL 100 or SL 150	69
Manual registration: Gigaset 1000 to 4000 and other handsets with GAP functionality	69
De-registering handsets	70
Looking for a handset ("Paging")	70
Changing the base station	70

Using several handsets 71

Internal calls, ending a call	71
Changing the name of a handset	71
Changing a handset's internal number	72
Internal enquiry calls	72
Accepting/rejecting call waiting during an internal call	73
Listening in to an external call	73
Call Director (calling a specific handset) (SL 150 only)	74
Using a handset as a room monitor	75
Setting the Walk and Talk mode	78

Handset settings 80

Changing the Display language	80
Activating/deactivating Auto Answer	80
Adjusting the loudspeaker volume	80
Changing the ringer	81
Sound Manager	84
Activating/deactivating advisory tones	85
Restoring the handset factory settings	86

Setting the base station 87

Protecting the telephone from unauthorised access	87
Emergency numbers	88
Changing the name of the base station	89
Repeater support	89
Restoring the base station to factory settings	89

Connecting the base station to a PABX 91

Dialling modes and and recall	91
Storing the access code (outside line code)	91
Setting pauses	92
Switching temporarily to tone dialling (DTMF)	92

Appendix 93

Care 93

Contact with liquid 93

Questions and Answers 93

Service (Customer Care) 95

Specifications 97

Answering machine remote operation (SL 150 only) 98

Character set chart 98

Predictive text 100

PC Interface 101

"Balloon Shooter" Game 102

Accessories 103

Menu Tree 106

Main menu 106

Directory key and speed dial list key 108

Calls List/Answering Machine List (SL 150 only) 108

Index 109

Safety precautions



Only use **the power supply unit supplied**, as indicated on the underside of the device.



Fit only the **recommended rechargeable battery (page 97)**! Use no other types of batteries or non-rechargeable batteries, as they could damage health and cause personal injury.



Insert rechargeable batteries in accordance with the polarity symbols and use the battery type recommended in these operating instructions.



The operation of medical appliances may be affected. Be aware of the technical conditions within the particular environment (e.g. doctor's practice).



The handset may cause an intrusive "hum" in hearing aids.



Do not install the base station in bathrooms or shower rooms (page 93). The handset and base station are not watertight.



Drivers must not use their phones while driving (Walk and Talk function).



Switch off your phone while on board an aircraft (Walk and Talk function). Ensure that it cannot be switched on again accidentally.



Do not use the phone in environments subject to explosion hazard (e. g. auto paint shops).



Ensure that your Gigaset is accompanied by these instructions when you give it to others to use.



Dispose of the battery and phone in accordance with environmental regulations.

i

Not all of the functions described in these instructions are available in all countries.

Preparing to use your phone

The pack contains:

- ◆ a base station Gigaset SL 100 or SL 150,
- ◆ a SL 1 handset,
- ◆ one power supply unit with power cord,
- ◆ one telephone cord,
- ◆ one belt clip for the handset,
- ◆ one rechargeable battery,
- ◆ one charger (incl. power supply unit),
- ◆ one set of operating instructions.

Installing the base station

Hints on installing

The base station is designed to be operated in enclosed, dry areas at temperatures ranging from +5 °C to +45 °C. Install the base station at a central location in your home, e. g. in the hall.



- ◆ Never expose the telephone to: heat sources, direct sunlight, other electrical appliances.
- ◆ Protect your Gigaset from moisture, dust, corrosive liquids and vapours.

Range and signal strength

The base station has a range of approx. 300 m outdoors and up to 50 m indoors. The signal strength display shows the quality of the radio contact between the base station and the handset:

- | | | | |
|------|----------------------|------|---------------------|
| ▣▣▣▣ | Signal strength 100% | ▣▣▣▣ | Signal strength 75% |
| ▣▣▣▣ | Signal strength 50% | ▣▣▣▣ | low signal strength |
| ▣▣▣▣ | no signal (flashes) | | |

Preparing to use your phone

Connecting the base station

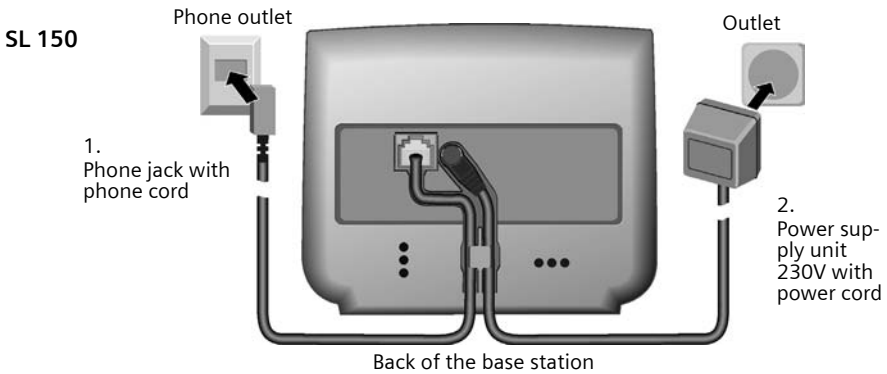
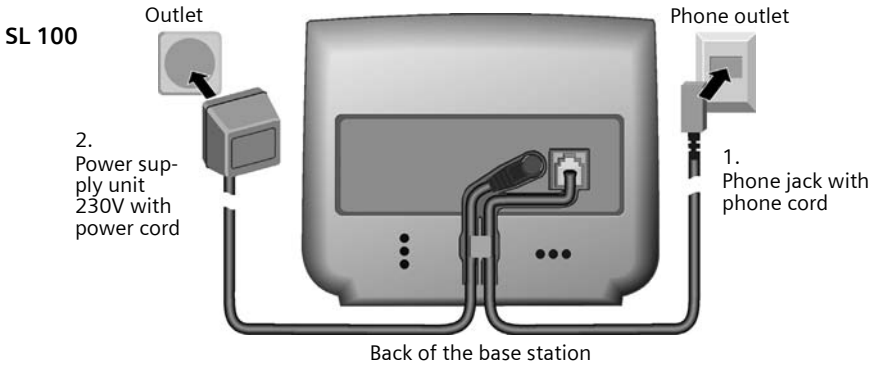

1.

- ◆ Fit the small jack on the phone cord into the socket in the base station (it clips into place),
- ◆ Place cord in cable recess,
- ◆ Fit phone jack into phone outlet.

2.

- ◆ Insert the small jack on the power cord into the socket on the underside of the base station,
- ◆ Place cord in cable recess,
- ◆ Plug the power supply unit into your power outlet.

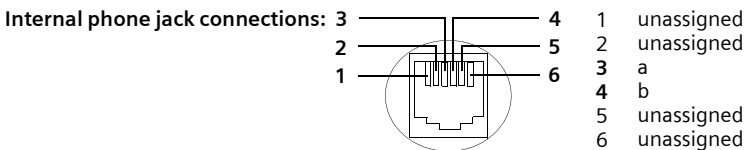

<i>i</i>	<ul style="list-style-type: none"> ◆ Keep the power supply unit plugged in at all times to ensure your phone is ready for use whenever you need it. ◆ If you ever purchase a phone cord from a store, ensure that the phone conductors are correctly connected (3-4 connection).
----------	---

Preparing to use the handset

Removing the protective film



The display is protected by a plastic film.
Please remove the protective film!

Inserting the battery





- ◆ Insert the battery **ensuring correct polarity** (see figure on the left).
- ◆ Position the battery cover so that it is **open by around 3 mm**, then slide **up** until it closes with a click.
- ◆ **To open** the battery cover, press on the grooved area and slide **down**.

⚡	<p>Use only the rechargeable battery recommended by Siemens on page 97! Never use conventional batteries (non-rechargeable) or other battery types as this may cause significant damage to health and property. For example, the jacket of the battery could be destroyed (hazardous). The phone could also malfunction or be damaged.</p>
---	--

Preparing to use your phone

Placing the handset into the charging unit and charging the battery

1. Plug the charger unit mains adapter into a mains socket.
2. Place the handset in the charger unit with the **display up**.
3. The handset is already registered with the base station. "INT 1" appears in the display. This means that the handset has been assigned the first internal number. You can change the handset name "INT 1" (page 71).
If something goes wrong, you will have to register the handset manually as described from page 69. You can get help from a table containing basic questions and answers (page 93).
4. Now leave the handset in the charger for the battery to charge – the battery is supplied uncharged. Battery charging is indicated in the top right of the display by the battery icon  flashing:

 Battery (almost) flat

 Battery $\frac{2}{3}$ charged

 Battery $\frac{1}{3}$ charged

 Battery fully charged



To register **additional handsets**, refer to page 69.



For the initial charge we recommend a continuous, uninterrupted charging period of five hours, whatever charge status is indicated. After a while the charge capacity of the battery will decrease for technical reasons.

The battery charging status is correctly displayed only after **uninterrupted charging/discharging**. You should therefore avoid removing the battery unnecessarily and ending the charging process prematurely.



- ◆ Once initial charging is complete, you can replace your handset in the charging shell after each call. Charging is controlled electronically. This ensures that the battery is charged in a way that maximises its life.
- ◆ The battery heats up during charging. This is normal and not dangerous.

Note

Your telephone is now ready for use. With the Gigaset SL 150, the answering machine is also activated with the pre-recorded announcement. To correctly record the time of calls and, if applicable, messages (SL 150 only) you have to now set the date and time (page 15).

Attaching the belt clip

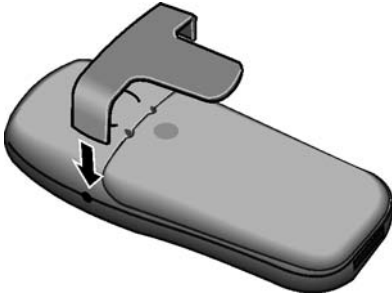

Push the belt clip onto the back of the handset until the lugs click into the recesses on either side of the handset.

Activating/deactivating the handset

To activate hold down the end call key . You will hear a confirmation tone.





A deactivated handset activates automatically when placed in the charger.

Activating/deactivating the keypad lock

You can "lock" the keys on your handset, e. g. when carrying the unit in your pocket or bag. This protects the keypad against inadvertent activation.

Activating keypad lock:

Press the hash key  **and hold** (confirmation tone).

The  icon appears in the display.

The keypad icon is still displayed even if you have loaded a screensaver (page 51).

When the keypad lock is active, you cannot even call emergency numbers.

Deactivating keypad lock:

Press the hash key  **and hold** down (confirmation tone). The keypad lock deactivates automatically when you receive a call. It re-activates when the call is finished.

Operating the telephone, menu guidance

Keys





Control key

The control key is the central operating key. It has four black arrows and icons. A certain function is activated depending on which side of the key you press (up, down, right or left). In the operating guide, the side you have to press is shown with a black triangle, e.g.: key  for right = Open menu.

Example:



Different functions of the control key:

	In the idle status	In lists and menus	In an input field
	Initiate voice-activated dialling (long press)	Scroll up	Move the cursor up a line
	Open directory	Scroll down	Move the cursor down a line
	Open the menu	Confirm the selected option (same as OK)	Move the cursor to the right
	Open list of handsets	Go back one menu level, or cancel	Move the cursor to the left



You can also use the **control key** to execute many of the functions of the **right-hand display key**.





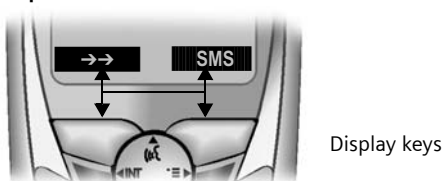

Display keys

The display keys are the **horizontal rocker keys** just below the display. Their function changes depending on the particular operating situation. The current function is shown in the display directly above the key to which it relates.

Example:



The various functions are explained below:

Display Icon	Meaning when key is pressed
	Last number redial key: Open the list of the last 10 numbers you dialed.
	OK key: Confirm menu function or confirm an input and store.
	Menu key: Open the main menu when in idle status Open a status-dependent menu while making a call.
	Delete key: Delete input from right to left one character at a time.
	Escape key: Go back one menu level, or cancel the operation.
	Open email directory.

Correcting wrong input

After a correct input you will hear a confirmation tone (rising tone sequence), an incorrect input is indicated by an error tone (falling tone sequence). You can repeat the input. If you have entered incorrect characters **in the text**, you can correct them as follows:

Deleting characters to the left of the cursor with

To correct a telephone number or text, use the control key to move the cursor to the right of the incorrect character. Now press display key . The character is deleted. Now enter the correct character.

Inserting characters to the right of the cursor

If you have omitted a character, use the control key to go to the place where you want to insert the character, and key it in.

Overwriting characters to the right of the cursor

When entering **Cost per Unit:**, the number of digits is fixed and the field is preset. Use the control key to move the cursor to the **left** of the incorrect digit and overwrite it.

Idle status

Display in idle status (example)

Gigaset SL 100

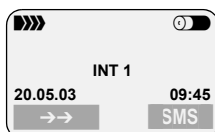

Time and date are already set

Gigaset SL 100

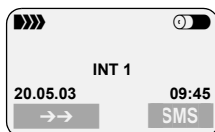

Time and date are already set

or

Gigaset SL 150

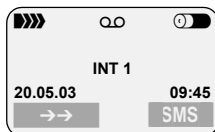







Time and date are already set

Reverting to idle status from anywhere in the menu:

- ◆ Press the "end call" key  for about 1 second, or
 - ◆ Press no key: The display **automatically** reverts to the idle status after 2 minutes.
- Changes which you have not confirmed or saved by pressing **OK**, **Yes**, **Save**, **Send** or with **Save** **OK** will be lost.

Menu operation, with "Handsfree Volume setting" as an example



1.  Press the right side of the control key. The menu opens.
2.  Press the display key repeatedly until **Audio Settings** appears on the screen.
3.  or **OK** Confirm by pressing the right side of the control key or the display key.
4.  or **OK** Confirm the first display entry, **Handset Volume**, by pressing the right side of the control key or the display key.
5.  Press the left or right side of the control key to select the required volume (1–5).
6. **Save** Now press the display key to confirm the setting.
7.  Press and **hold** the "end call" key to return to the idle status.

Date and Time

Setting the date and time

Correct date and time settings are essential if you want to know exactly when calls/messages (SL 150) were received. You can choose between 12-hour and 24-hour display (factory setting) for the time (a.m. = 1st half of the day; p.m. = 2nd half of the day).

 → **Calendar/Clock** → **Date/Time**

	Entering the date: Enter the day/month/year in the Date: line.
	Entering the time: Scroll to the Time: line and enter the hours/minutes (4-digit).
	Selecting display mode: Scroll to the Time Mode: line and choose between 12-hour and 24-hour mode.
Save	Now press the display key to confirm the entry.





If you have selected the 12-hour display, on the **Time:** line you can use the display key **am/pm** to toggle between **am** and **pm**.

Setting the alarm clock

Precondition: You have set the date and time.

Activating and setting the alarm clock

 → **Calendar/Clock** → **Alarm Clock**



	Activating the alarm clock: In the line Room M.: select On .
	Entering the alarm call: Scroll to the Time: line and enter the hours/minutes (4-digit), e.g.  for "7:15 a.m.".
am/pm	If 12-hour mode is set: Now press the display key to switch between am and pm .
Save	Now press the display key to confirm the entry.
	Long press (back to idle status). You will see the  .

i

- ◆ The alarm will only ring if handset is in the idle status. There will be no alarm ring with room monitor activated, during a call or automatic last number redial.
- ◆ To find out how to set the wake-up volume and melody, turn to page 81.

Deactivating the alarm clock

 → **Calendar/Clock** → **Alarm Clock**

	In the line Room M.: select Off .
Save	Now press the display key to confirm the setting.
	Long press (back to idle status).

Deactivating the wake-up call



















The alarm rings on the handset with the selected ringer melody. **Alarm Clock** appears in the display. Press the display key **Silence** to cancel the wake-up call. The alarm will ring for 60 seconds if it is not answered.

Setting an appointment

You can use your handset to remind yourself of up to five appointments. To find out how to set the volume and melody, turn to page 81.

Activating and setting an appointment



 → **Calendar/Clock** → **Set Appoints.**

 Appoint. 2 OK	Select the appointment (1-5) and confirm.
	Setting an appointment: In the line Room M.: select On .
 	Enter the date: Scroll to the Date: line and enter the day/month (4-digit). Example: For 20.05. enter     .
 	Enter the time: Scroll to the Time: line and enter the hours/minutes (4-digit). Example: For 9:05 enter     .
am/pm	With 12-hour display (page 15): Switch between am and pm
 Edit	Naming the appointment: Scroll to the Notes: line and press the display key.
 OK	Enter a name (up to 16 characters) and confirm (for inputting text see page 98). If you do not give the appointment a name, "Appointment..." will appear in the display when it is due.
Save	Now press the display key to confirm the entry.
	Long press (back to idle status). You will see the  icon.

i	The handset will only display an appointment when it is in the idle status. No appointment will be displayed with room monitor activated, in Walk and Talk mode, during a call or automatic last number redial.
----------	---

Canceling an appointment

 → **Calendar/Clock** → **Set Appoints.**

 Appoint. 2 OK	Select the appointment (1-5) and confirm.
	Select Off .
Save	Now press the display key to confirm the setting.

Switching off or answering an appointment





An appointment call sounds with its selected ringer melody (page 82). **Appoint. 2** appears in the display, for example. Press display key **Silence**, to deactivate the appointment call or **SMS** to reply with an SMS message. The appointment call will ring for 30 seconds if it is not answered.

<i>i</i>	When an appointment is displayed, you can use the display key SMS to open the SMS menu and write and send a text message.
----------	--

Viewing missed appointments, anniversaries

Appointments and anniversaries (page 25) that have been indicated but not acknowledged are stored in a list. If the handset is switched off at the time of the appointment/anniversary, it is also stored in the list.

 → **Calendar/Clock** → **Missed Dates**





	Select the appointment/anniversary. Information about appointment/anniversary is displayed. A missed appointment is indicated by  , a missed anniversary by  .
either ...	Closing the list:
	Short press.
or ...	Deleting an appointment/anniversary:
Delete	Press the display key.
... then	
	Long press (back to idle status).

<i>i</i>	<ul style="list-style-type: none"> ◆ If the list contains a new appointment/anniversary, Appoint appears in the display. You can also use this display key to open the appointment/anniversary list. Once you have looked at all the new appointments, Appoint will no longer be shown in the display. ◆ If the list does not contain any appointments/anniversaries, use Go Back to close the list.
----------	---

Making calls

Making external calls and ending a call



External calls are calls into the public telephone network.

	Enter the number and press the talk key. The telephone number is dialed. You can also press the talk key  first (you hear the dialling tone) and then enter the number.
	Press the end call key. You can use the end call key  to cancel the dialling operation.

Dialling pause

You can insert a dialling pause between the prefix and the actual telephone number. To do this, press  for about 2 seconds. Now enter the telephone number.

Answering a call

Your handset rings, the call is displayed on the screen and the handsfree key  flashes. You can accept the call by pressing the talk key , the display key **Accept** or the hands free key . If the handset is in the charger and the **Auto Answer** function is activated (page 80), then you just need to lift the handset out of the charger to take the call.

	If the ringer is intrusive , press the display key Silence . You can take the call so long as it is displayed on the screen.
---	--

Calling Line Identification

When you get a call, you will see the caller's number and/or name displayed on the screen.

Preconditions:

1. You have asked your network provider for the caller's number (CLIP) or name (CNIP) to be displayed on your handset screen.
2. The caller has asked the network provider for his number to be identified (CLI).
3. Your network provider supports CLIP, CLI and CNIP.

CLI	Calling Line Identification
CLIP	Calling Line Identification Presentation
CNIP	Calling Name Identification Presentation

Screen display with CLIP/CLI

With calling line identification, the caller's telephone number is displayed on the handset screen. If you have stored an entry for this number in your directory, then that entry will be displayed instead of the number, e. g. "Anna".

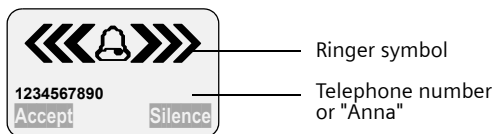

The screen displays **External** if the number is not identified.

The screen displays **Withheld** if the caller withholds his or her number, or **Unavailable**, if he or she has not requested CLI.

Screen display with CNIP

If you have CNIP, then the name (town) that is registered with your network provider for the calling number will **also** be displayed on your handset.

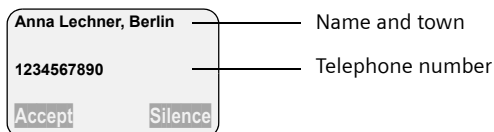

The screen displays **External** if the number is not identified.





The screen displays **Withheld** if the caller withholds his or her number, or **Unavailable**, if CLI has not been requested.

Making calls

Handsfree

Activating/deactivating handsfree



You should inform your caller that you intend to use the handsfree function before you activate it. If you wish to place the handset in the charger during a call you have to press the handsfree key  and hold it down as you do so.

 	Activate while dialling: Enter the number and press the handsfree key (instead of the talk key ).
	Activate during a call: Press the handsfree key.
	Deactivating: Press the talk key

As soon as you terminate the handsfree mode you switch to "earpiece mode" and continue the call on the handset.



Adjusting the volume while in handsfree mode

A call is in progress and handsfree  is activated.

	Press the handsfree key again .
	Decrease or increase the volume.
Save	Now press the display key to confirm the setting.

Muting

You can mute your handset during external calls, e.g. if you wish to talk confidentially to another person in the room. The external caller cannot hear your conversation during this time (hold melody). You do not hear your caller either.

	Open list of handsets. The call is "held" (wait melody).
	Cancel muting: Press the display key.

Using the directory and other lists

Directory and speed dial list

The directory and speed dial list can store up to 200 numbers, depending on the length of the entries, the number of entries in the speed dial list and the email directory (page 29).





The **directory** makes dialling easier. You open the directory in idle status with the  key. You can store an anniversary/birthday for every directory entry and mark the entry as "VIP".

The **speed dial list** is a special directory in which you can store particularly important numbers such as private telephone numbers and prefixes of network providers (so-called "call-by-call numbers"). You open the speed dial list with the  key.









You create the directory, email directory and speed dial list for your individual handset. You can send the lists/individual entries to the other handsets if you want them to be available at other handsets as well (page 24).

The speed dial list is operated in just the same way as the directory, except for the way in which entries are stored.

i

- ◆ The **EATONI** predictive text helps you input names (page 100, this feature is deactivated when you purchase your phone).
- ◆ Please refer to the **Character Set Chart** (page 98) to see how to enter text correctly.
- ◆ You can enter up to 32 digits for a number and up to 16 letters for a name.
- ◆ When entering a number you can insert the required pause with ,  **Insert Pause**  or by pressing  for about 2 seconds.

Storing a telephone number in the directory

 → New Entry	
	Creating the entry: Enter the telephone number.
 	Scroll to the next line and enter the name.
either ...	Storing an entry:
	Press the display key to open the menu.
Save 	Confirm. The entry is stored.
or ...	Entering an anniversary before storing:
	Scroll to the Annivers.: line if you want to enter an anniversary, as described on page 25. Then:
	Now press the display key to confirm the entry.
... then	
	Long press (back to idle status).









i	If your phone is connected to a PABX you may have to enter the access code (outside line code) as the first digit of your directory entry (page 91).
----------	--

Storing a telephone number in the speed dial list







You can assign one of the digits 0, 2–9 to **up to nine** entries on your speed dial list. Entries with speed dial digits appear at the head of the list. Already assigned digits will not be available. When you press and hold one of these digits with the handset in the idle status, and then press the talk key , you are immediately connected to the telephone number that is assigned to that digit.

The maximum number of entries in the speed dial list depends on the number of entries in the directory and email directory.



 → **New Entry.**



	Creating the entry: Enter the telephone number.
 	Scroll to the PublicKey: line and enter the name.
either ...	Storing a number:
	Press the display key to open the menu.
Save 	Confirm. The entry is stored.
or ...	Storing a speed dial digit:
 	Scroll to the Enter key: line and enter a digit (0, 2–9) for this number.
	Now press the display key to store the setting.
... then	
	Long press (back to idle status).



Dialling with the directory/speed dial list

 or 	Open the directory or speed dial list.
either ...	Scrolling to the entry:
	Select entry.
	Press the talk key The number is dialled.
or ...	Entering the first letter:
	Enter the first letter of the name you are looking for, e.g. "N".
	You can also enter the next letters: "N" appears in the line directly above the display key (input field). Enter the 2nd letter e. g. "i". You will now see the name coming closest to this combination. The entry field now contains "Ni". Continue entering letters (up to 10) until you see the name you want.
	Press the talk key The number is dialled.

Managing entries in the directory and speed dial list



Press the directory key  or the speed dial list key . Use the  key to scroll to the entry you want.

Or:  or ;  (enter first letter); if necessary scroll with  or

 enter more letters of the name; .

◆ To view or edit the entry, press display key **View** and then **Edit**.

Make the changes you want and then press  **Save Entry** **OK**.

◆ To use one of the following menu functions, press  to open the menu. Use the  key to scroll to the function you want.

Display	Menu function
Display Number	You can change or add to a stored number and then dial it or use other functions by pressing  .
Edit Entry	Change a selected entry.
Delete Entry	Delete a selected entry.
VIP Entry (directory only)	You can mark the directory entries of particularly important callers as VIP (Very Important Person); this links a particular melody to them. You can then tell who is calling you by the ringer melody. Precondition: Calling Line Identification.
Copy and Edit (directory only)	So that you do not have to enter a similar entry twice, you can create a copy and then edit that entry.
Copy Entry	Send an entry to a different handset. See the explanation following the table.
Delete List	Delete all the entries in the directory and speed dial list.
Copy List	Send a complete list to a different handset. See the explanation following the table.
Available Memory	You can see how many more entries can be saved.

Using the directory and other lists

Transfer a directory or speed dial list to another handset.

Precondition:

You can only transfer numbers if the receiving and sending handset are registered with the same base station.

To do this:

1. Select the menu functions Copy Entry or Copy List.
2. Enter and confirm the internal number of the receiving handset.
 - After an entry has been sent you are asked if you want to send another entry. If you want to transfer more entries, confirm by pressing display key **Yes**.
 - If you want to terminate transfer, confirm by pressing display key **No**.
3. The successful transfer of data is confirmed with a message and with the confirmation tone at the receiving handset.





Note:

- ◆ VIP settings, stored voice patterns and speed dial digits are not sent.
- ◆ Entries with identical telephone numbers are not overwritten during transfer. The number of entries that are stored in the receiving handset may therefore differ from the number of entries that you have sent to it.
- ◆ The transfer is cancelled if the phone rings or if the memory of the receiving handset is full. The last entry to be transferred appears in the display.

Adding a displayed telephone number to the directory

If a call number (CLIP) or a call number and the corresponding name (CNIP) are shown in the display, you can transfer them to your directory. This can be done while dialling from the last number redial list, from the calls list/answering machine list(SL 150 only) or during a call.









 → **Copy to Directory**

	If you do not have CNIP: Scroll to the name line and enter the name.
either ...	Storing an entry:
	Press the display key to open the menu.
Save Entry 	Confirm. The entry is stored.
or ...	Storing an anniversary:
	Scroll to the Annivers.: line if you want to enter an anniversary, as described on page 25. Now:
	Press the display key to confirm the entry.

Selecting a number from the directory

If you are prompted to enter an external telephone number while you are operating your telephone, you can use your handset's directory to do this.

Precondition: The input field for external telephone numbers is displayed.









either ...	
	
 Directory 	Select the menu item and confirm.
 	Select the entry and confirm.
or ...	
	Open the directory.
 	Select the entry and confirm.



The entry's number is transferred to the entry field.

Saving an anniversary for a number (reminder call)



You have to enter a time so that the anniversary can be indicated by a ringer melody.



Precondition: You have opened a directory entry (page 22).

 	Scroll to the Annivers.: line and press the display key.
 	Enter the day/month (4-digit) in the Date: line.
 	Scroll to the Time: line and enter the hour/minutes (4-digit) when you want the indication (reminder) to ring.
 	Scroll to the Prompt: line and enter a reminder melody (polyphone melody, melody 1–10 or "visual").
	Confirm. The directory entry will be displayed again. Now save the entry as described on page 22.

To delete an anniversary, while in the **field for the anniversary** in the directory entry, press display key , then when the display changes press display key  and finally after another display change press .

Anniversary reminder call

The handset sounds a reminder call with the selected ringer melody. The display shows the directory entry with   .

either ...	Canceling a reminder call:
	Press the display key.
or ...	Answering with an SMS:
	Press the display key. This takes you straight to the SMS menu.

Using the directory and other lists

Voice-activated dialling





With voice-activated dialling, you dial simply by speaking the name of the person you wish to call. To do this, you first have to store a voice pattern, i.e. the name which you speak will be stored in the handset.

Up to four users can record a voice pattern for an entry. Before users record a voice pattern, they first have to "identify" themselves, e.g. as **User 2**.

A **maximum** of 23 voice patterns can be stored for directory entries. If a voice pattern is stored for an entry in the directory, then that entry is marked .

Recording a voice pattern for an existing entry

Record your voice pattern in quiet surroundings. The handset should be around 25 cm away from you.

	Step 1: Open the directory for voice-activated dialling:
	Open the directory.
 Voice	Select the entry and press the display key.
 User 2 OK	Select and confirm, e.g. User 2 .
	Step 2: Begin recording:
record.	Press the display key.
OK	Confirm the display prompt. Speak the name when prompted to do so by the display. Repeat the name when prompted to do so. Your recording is stored automatically.
	Long press (back to idle status).

If you want to **change** the voice pattern, you have to delete it (page 27) and then record it again.

i	<ul style="list-style-type: none">◆ If your two recordings are too different from each other, you will be prompted to repeat them.◆ A message tells you if your speech pattern is too much like another user's. Close this message with , go back to the start of the voice pattern recording sequence and repeat the recording.
----------	--

Using voice-activated dialling

	Press.
---	---------------

The display prompts you to speak. Select the voice pattern, e.g. **Anna**. If the name matches the recorded voice pattern, it is repeated. The telephone number is dialled.

Phone announces the caller's name

When you receive an external call, you hear the ringer and can also have the telephone announce the caller's name.

Precondition: Calling Line Identification is active (page 18) and you have recorded a voice pattern for the incoming number (page 26).

Activating/deactivating the name announcement



→ **Audio Settings** → **Ringer Settings**

Ext. Calls	OK	Confirm. You hear the current volume.
		Scroll to the Announce line and activate/deactivate name announcement.
Save		Now press the display key to confirm the setting.
		Long press (back to idle status).

Playing the voice pattern

Open the directory for voice-activated dialling (see **Step 1**, page 26). **Now:**

	Select the entry with .
Play	Press the display key.
	Long press (back to idle status).

Deleting voice patterns

Deleting a voice pattern for an entry does not affect its number or name – they are retained. This does not affect the voice patterns of the other users.

Open the directory for voice-activated dialling (see **Step 1**, page 26). **Now:**

	Select an entry (highlighted with) and open the menu.	
Delete Name	OK	Select the menu item and confirm. The entry is displayed without .
	Long press (back to idle status).	



Changing a user name

	Open the directory.
Voice	Select an entry and press the display key.
User 2	Select the user, e.g. User 2 .
Edit	Now press the display key to start making the changes.
Save	Enter the new name and save it.
	Long press (back to idle status).

Last number redial list

The last number redial list contains the ten last dialled numbers. If names have been stored for these numbers in the directory, then the names will be displayed.

Manual last number redial



	Open the last number redial list.
	Select the entry and press the talk key. The telephone number is dialled.

	If a name is displayed, use display key View to show the corresponding number.
---	---

Managing entries in the last number redial list

 (open the redial list);  (select an entry);  (open menu);
 (select function).









You can use the following menu functions:

Display	Menu function
Automatic Redial	This function dials the number automatically every 20 seconds. The talk key flashes and the loudspeaker is activated. If the other person answers, press the talk key  . If the call is not answered, ringing stops after about 30 seconds. The function is cancelled after ten failed attempts. If you receive a call in the meantime, automatic dialling switches itself off. You will then have to re-activate it.
Display Number	You can change or add to a stored number in the redialling list and then dial it or use other functions by pressing  .
Copy to Directory	Transfer selected entry to the directory.
Delete Entry	Delete a selected entry.
Delete List	Delete all entries.

Email directory





Use the email directory to store email addresses you need, for example for sending text messages to email addresses. You can save about 200 entries in the email directory, the telephone directory and the speed dial list.

Storing a new email address

		Step 1: Open the email directory:
		Open the directory.
 Deleting	OK	Select the menu item and confirm.
		Step 2: Create the entry:
New Entry	OK	Confirm.
		Enter the address (for text input see page 98).
		During entry...
		Press the display key to open the menu.
either ...		Insert period:
 Insert '.'	OK	Select the menu item and confirm.
or ...		Insert @:
 Insert '@'	OK	Select the menu item and confirm.
or ...		Activating/deactivating predictive text (page 100):
 Predictive Text	OK	Select the menu item and confirm.
... then		Store the email address.
		Press the display key to open the menu.
Save Entry	OK	Confirm. The entry is stored.
		Long press (back to idle status).

Opening an email directory, viewing and changing an address











Precondition:You have opened the email directory (page 29).

 View		Select the entry and press the display key. The number is displayed.
		Changing an entry:
Edit		Press the display key.
		Change the address.
		Press the display key to open the menu.
Save Entry	OK	Confirm. The entry is stored.
		Long press (back to idle status).

Using the directory and other lists





Deleting or copying an email address

Precondition: You have opened the email directory.

 	Select an entry and open the menu.
either ...	Deleting an email address:
 Delete Entry 	Select the menu item and confirm.
or ...	Copying an email address:
 Copy and Edit 	Select the menu item and confirm.
	Change the address if necessary.
	Press the display key to open the menu.
Save Entry 	Confirm. The entry is stored.
... then	
	Long press (back to idle status).







Deleting the entire email directory

Precondition: You have opened the email directory.

 	Select any entry and open the menu.
 Delete List 	Select the menu item and confirm.
	Long press (back to idle status).

Display available memory





The memory space is divided up between the directory, the speed dial list (page 21) and the email directory (page 29). The available memory of all the lists is displayed.

	Open the directory.
 	Select any entry and open the menu.
 Available Memory 	Select the menu item and confirm.
	Long press (back to idle status).

Opening lists with the message key

You can use the message key  to open the following lists:

1. SMS list (wenn mehrere Postfächer eingestellt sind, werden diese aufgelistet),
2. Answering machine list **or** mailbox 1, mailbox 2, mailbox 3 (page 55) (SL 150 only),
3. Calls list.



As soon as a **new entry** (a call, a message on the integrated answering machine (SL 150 only) and/or a text message) arrives in one or more of the lists, the  key flashes and you hear an advisory tone. If you now press the flashing  key but you do not open any of the lists but instead close the menu, the  key continues to flash. If you press the flashing  key and open one of the lists, when you close the list the key will stop flashing even if one of the other lists still contains **new** entries. If there is at least **one** new entry, you can set the  key "flashing" again, i.e. reactivate it. This will let others, e.g. members of your family/your office colleagues, know that they have received new messages.

The following lists are displayed when you press :

- ◆ If only one list has new entries, you will see the first new entry in that list; handelt es sich um Einträge in einem persönlichen Postfach, wird die zugehörige Liste angezeigt.
- ◆ If several lists have new entries, those lists are offered for your selection.
- ◆ If there are no new messages in any of the lists, then all the lists are offered for your selection.
- ◆ If calls are stored in the network mailbox, you will see a message if the correct setting has been made (refer to the network mailbox operating instructions).

Setting the message key to "flashing"/deactivating the message key

Precondition: There is still one new entry in one of the lists.

		Open the calls list.
	Mark as new	OK Select the menu item and confirm.
		Long press (back to idle status).

The key only flashes until it is pressed again and a list or list entry is opened.

Calls list and answering machine list(SL 150 only)

The numbers of the last 30 calls are saved in the **calls list**. The oldest entry is deleted when the calls list is full and new entries are added.

Precondition: The caller's number has been identified (page 18).

Depending on the setting, either **All Calls** or only **Missed Calls** (factory setting) will be saved (page 33).

Depending on this setting, several calls from the same number are entered in the calls list as follows:

- ◆ More than once when **All Calls** is set,
- ◆ Once and only the last missed call when **Missed Calls** is set.

Using the directory and other lists

Here is an example of how the calls list ("Calls List:") appears in the display:

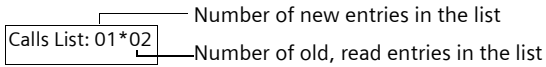

You can use the **answering machine list** to listen to the messages that are on the answering machine on the Gigaset SL 150. The date and time of arrival and caller's number of each message is displayed provided they are identified.

Once you have listened to them, the new messages are added after the old messages in the answering machine list.

Here is an example of how the answering machine list (**Ans M.:**) appears in the display:

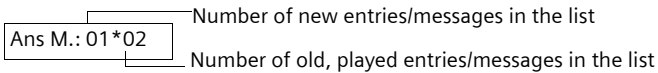

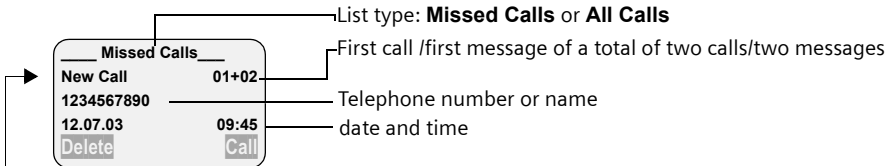

Example for a list entry:







This entry shows the status of a call/message:

- New Call The call is new in the list.
- Old Call The call is old in the list.
- Answ. The call was taken
(**All Calls** setting only, page 33).
- AM answ. SL 150 only: The answering machine answered the call but the caller did not leave a message ("All calls" setting only, page 33).
- New Msg. SL 150 only: The message is new in the list.
- Old Msg. SL 150 only: The message is old in the list, it has already been played.

Caller list settings

 → **Calls List: 01+02** →  → **Calls Settings**







The current selection is marked ✓.

either ...	Only calls which you could not take:
Missed Calls 	Confirm.
or ...	All calls:
 All Calls 	Select the menu item and confirm.
	Long press (back to idle status).

i	<ul style="list-style-type: none"> ◆ The currently set list type is shown in the calls list display heading. ◆ Changing the list type does not affect the existing entries in the list.
----------	---

Opening the calls list/answering machine list (SL 150 only)

New calls (calls list) and new messages (answering machine) are indicated by the  key flashing and by a confirmation tone.

	Press.
either ...	Open the calls list:
 Calls List: 	Select the menu item and confirm. The entry received last is displayed.
	Select entry.
or ...	Opening the answering machine list:
 Ans M.: 01+02 	Select the menu item and confirm. The entry of the first new message to arrive is displayed. The loud-speaker activates. Message playback begins.
	Scroll to the next or previous message. The entry of the message appears in the display. Message playback begins.



i	To delete an entry or a message (SL 150 only), press Delete .
----------	--

Using the directory and other lists

Calling back a caller

Precondition: The caller's number has been identified (page 18).

Open the calls list/answering machine list (SL 150 only). **Now:**





	Select entry.
either ...	
Call	Press the display key.
or ...	
	Press the talk key once (calls list) or twice (answering machine list).

This immediately initiates ringback. The telephone number is entered in the last number redial list.

Viewing an entry in the calls list and adding it to the directory

Open the calls list/answering machine list (SL 150 only) and select an entry. **Now:**

 → **Copy to Directory**





 	Scroll to the Name line and enter the name (for text input see page 98). If you have got CNIP, the first 16 characters of the name sent will be displayed.
	Press the display key to open the menu.
Save Entry 	Confirm. The entry is stored.
	Long press (back to idle status).

i

Gigaset SL 150: When picking a telephone number from the answering machine list, message playback is interrupted when you press . Playback will resume when the telephone number has been stored in the directory.

Deleting the calls list

Open the calls list (page 33). **Now:**

	Open the menu.
 Delete Calls List 	Select the menu item and confirm. Caution: All old and new entries will be deleted.
	Long press (back to idle status).

Deleting old messages from the answering machine list is explained on page 61.

Deleting an individual entry from the calls list/answering machine list (SL 150 only)

Open the calls list/answering machine list and select an entry (page 33). **Now:**

Delete	Press the display key.
	Long press (back to idle status).

SMS (Text Messages)

You can send and receive SMS text messages (**Short Message Service**) with your handset. You can write, edit, read, delete or forward text messages from any registered handset. When several handsets are in use at any one time, only **one handset** can access the SMS function.

i

Please remember that when the SMS function is active **the first ring is suppressed** (page 84).

General

Text messages are exchanged between SMS centres that are operated by service providers. The telephone number of the SMS centres through which you wish to send and receive text messages have to be entered in your phone. Up to five SMS centres can be entered. SMS centres may be preconfigured at the factory. You can change the telephone numbers of the SMS centres.

i

If your phone is connected to a PABX, you may have to prefix the telephone number with an access code (page 91) (this depends on your PABX).

You can receive text messages from **any** of the SMS centres whose number you have entered. Of course you have to be registered to receive text messages with those SMS centres.

Sending text messages to email addresses

If you wish to send text messages to email addresses you have to make additional settings for the send centre on your phone (page 37). Ask your service provider if it supports the "SMS to email" service and what settings you have to make.

Storage capacity

The number of text messages that can be stored in the base station depends on the size of the messages. The memory is also used for the incoming and draft message lists. When the memory is full, you are prompted to delete messages.

Before you can send and receive text messages

- ◆ Calling Line Identification (page 18) has to be enabled for your phone line. Check with your telephone network provider to make sure that this service is activated on your phone line. You may have to apply for it to your network provider.
- ◆ To receive text messages you have to be registered with your service provider.
- ◆ No network blocks have to be set.

Ask your telephone network provider





- ◆ what charges are billed for sending and receiving a text message,
- ◆ which mobile phone operators you can send text messages to and which mobile phone operators you can receive text messages from,
- ◆ which functions your SMS service offers,
- ◆ how you are registered with SMS centres which your phone may already be preconfigured for – automatically by sending a message or by a special registration procedure.

Sending and receiving text messages

To send and receive a text message, you have to enter the call numbers of the SMS centre of your service provider. These numbers may be preconfigured at the factory.

Activating and deactivating the send message and receive message functions

The text message "send" and "receive" functions are already activated when you purchase your phone.

	Open the menu.
	Initiate the setting.
either ...	Deactivating "Send/receive SMS":
	Enter and confirm.
or ...	Activating "Send/receive SMS":
	Enter and confirm.

The settings which you have made for sending and receiving text messages (e.g. the call numbers of the SMS centres, personal mailboxes etc.) and the entries in the incoming and draft message lists are saved when you switch off your phone. They are activated automatically when you switch on your phone again.

When you switch off you cannot send or receive any text messages with your phone. The first ring tone is signalled again (page 84).







Entering the number of an SMS centre, changing the send centre

You can enter and change the call number of an SMS centre. A previously stored SMS centre number is changed by being overwritten.

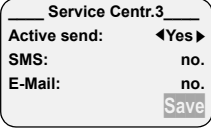
You should find out about the services and special functions offered by your service provider **before you make a new application** and/or before you delete pre-configured call numbers.

If your service provider supports the sending of text messages to email addresses you can also enter a number for the "SMS to email" service. You will then be prompted to use this number when sending a text message to an email address.

 → **SMS** → **Settings** → **Service Centres**

 Service Centr.3 OK	Select and confirm, e.g. Service Centr.3.. 
	If necessary select Yes in Active send: to activate Service Centr.3 as send centre. The previously selected send service centre is automatically deactivated.
 Edit	Scroll to the SMS: line and press the display key.
	Enter the call number of the SMS centre and open the menu.
Save Entry OK	Confirm.
 Edit	If necessary, scroll to the E-Mail: line and press the display key.
	Enter the number of the email service and confirm.
Save Entry OK	Confirm.
Save	Now press the display key to confirm the entry.
	Long press (back to idle status).

	Ask your service provider for details of how you should enter service numbers if you wish to use personal mailboxes (assuming your service provider supports this function).
---	--

Text message sending and the draft message list

If a call arrives while you are writing a message, then the message is automatically saved to the **draft message list**. You can take the call and finish writing the message later (page 41).

Text messages that **cannot** be sent are assigned an error status (page 53) and are placed in the **incoming message list**.

Text messages are only stored automatically if sending is interrupted.

If you wish to store a message then you have to do so **before it is sent**.



Your phone line is busy while your text message is being transmitted to the SMS send centre. The message **SMS being sent** is displayed on all handsets.

<i>i</i>	Remember that some service providers will bill you for a cancelled call to the SMS centre.
-----------------	---





Writing text messages

A **single** text message can be up to 160 characters long. If your text is longer, it will be sent **automatically** as a **linked** message. Up to four messages with 153 characters each can be linked. You can enter up to 612 characters. Remember that linking messages incurs higher charges.

Remember that the service provider cannot deliver a text message that contains Greek or Cyrillic characters. If you have set Greek or Russian as your display language, you will need to change the input language **before** you write a message.

When you have opened the input window for the text message, press display key . From the menu, select **Select Language** and then press **OK** to confirm your choice. Now select an input language that uses the **Roman** character set (e.g. **German** or **English**). Press **OK** to confirm your selection and then briefly press the end call key  twice to return to the input window. The setting of the input language only applies to the current text message. You write a text message like this:

 → **SMS**

 Mailbox 1 	If more than one mailbox is activated (page 48), select a mailbox and confirm, e.g. Mailbox 1 .
 OK	If required, enter the mailbox PIN and confirm.
Write Message 	Confirm. The input field opens.
	Input your text (for text input see page 98).

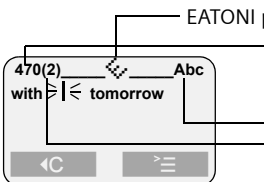





EATONI predictive text activated.



The counter shows how many more characters you can write. It counts from 612 characters downwards (maximum number of characters permitted with linking).

Upper/lower case and digits

The number in brackets indicates the message you are in (with linked messages). Example: You are in the second message.



Predictive text

The **EATONI** predictive text feature helps you write your message (page 100). The  icon indicates whether EATONI is active or not (factory setting: On). You can switch EATONI off at any time using ,  **Predictive Text** .

<i>i</i>	<ul style="list-style-type: none"> ◆ Please refer to the Character Set Chart (page 98) to see how to enter text correctly. ◆ Use  to insert a space, and  to toggle between upper case, lower case and digits (page 98). ◆ You can find out how to correct text on page 13. ◆ If you receive a text message that is incomplete (e.g. because your phone's memory is full), you will see a message.
----------	---

Storing text messages











Precondition: You have written a text message (page 38) and the input field is open.

	Press the display key to open the menu.
 Save Entry 	Select the menu item and confirm. You can send your text message later (see page 39).

The message is stored in the **draft message list**. It can be retrieved and sent at a later time (page 41).

Sending a text message without saving it

Precondition: You have written a text message (page 38) and the input field is open.

	Press the display key to open the menu.
Send 	Confirm.
SMS 	Confirm.
either ...	
	Enter the recipient's number (with prefix). <div style="border: 1px solid gray; padding: 5px; width: fit-content;"> <p>Send text messages to: 1234567890 > <</p> <p> </p> </div>
or ...	Selecting a number from the directory:
	Open the directory.
 	Select the entry and confirm. The number appears in the display.
... then	
	Press the display key to open the menu.
Send 	Confirm.

SMS (Text Messages)

<i>i</i>	<ul style="list-style-type: none"> ◆ The recipient's number always has to include the area code (prefix), even if you are in that area. ◆ When you send a text message to a specific SMS mailbox, you have to put the mailbox ID at the end of the phone number (page 49).
----------	--



Sending a text message to an email address

If your service provider supports the "SMS to email" service, then you can also send your text messages to email addresses. Ask your service provider what format you have to enter the email address in so that it can deliver your message as an email.



To send a text message to an email address, proceed as follows (example).

Inserting an email address at the beginning of text messages (SMS)





Enter the recipient's email address at the beginning of your text message. Separate the email address from the text of the message by a space or a colon (this depends on the provider). As long as the **text field** is still empty, you can copy the email address from your email directory (page 29). You send the text message to the number of the -email service of your SMS Centre.

If the predictive text feature is **off**, enter the "@" character using the hash key  (press 2x), the colon using the  key (press 8x) and the space with  (press once).

If predictive text is **on**, enter "@" by giving the hash key  1 long and 1 short press.

Use   **Save Entry**  to save what you have written so far.

Precondition: You are writing a text message (page 38) and the input field is open.



either ...	Copying the address from the email directory:
	Press the display key. Press the display key. This will be displayed as long as the entry field is empty. This opens the email directory (page 29).
 Anna@... 	Select the email address and confirm.
or ...	Enter the email address manually:
	Enter the full email address and end it with a space or a colon.

Entering the text of the message

	<div style="border: 1px solid gray; padding: 5px; width: fit-content;"> <p>Enter SMS text.</p> <p>580(1)  Abc</p> <p>p.smith@name.com</p> <p>Hi Peter > <</p> <p style="text-align: center;"> </p> </div> <p style="margin-left: 20px;">Email address, space, SMS text (example)</p>
	Press the display key to open the menu.
Send 	Confirm.
 E-Mail: 	Select the menu item and confirm.

Sending an SMS as email

You have to send the text message to the **number of the** email service. If the number of the SMS send centre's email service is entered (page 37), then this number is offered.

	<p>Enter the number of the email service if necessary.</p> <div data-bbox="476 227 685 352" style="border: 1px solid gray; padding: 5px;"> <p>Send e-mail to:</p> <p>≥ ≤</p> <p><C >≡</p> </div> <p>If the number of the send centre's -email service is entered (page 37), then this number is offered.</p>
	<p>Press the display key to open the menu.</p>
<p>Send</p>	<p>OK Confirm.</p>





Opening the draft message list

The **draft message list** shows you:

- ◆ Text messages which you saved **before you sent them** (page 39),
- ◆ Text messages you could not send because, for example, you were interrupted by an incoming call while you were writing the message.

These messages are stored until you delete them.

 → **SMS**



 Mailbox 2	<p>OK</p> <p>If more than one mailbox is activated (page 48), select a mailbox and confirm, e.g. Mailbox 2.</p>
 OK	<p>Enter PIN if necessary and confirm.</p>
 Outgoing	<p>OK</p> <p>Select the menu item and confirm.</p> <div data-bbox="476 870 688 995" style="border: 1px solid gray; padding: 5px;"> <p style="text-align: center;">Outgoing</p> <p>Saved 01/02</p> <p>Msg from unknown</p> <p>12.03.03 09:45</p> <p>Delete Read</p> </div> <p>Total number of saved SMS</p> <p>Serial number of the displayed SMS</p> <p>Use  to scroll through the list.</p>

<p>i</p>	<p>When the memory is full, you are prompted to delete messages.</p>
-----------------	--

SMS (Text Messages)

Reading and deleting text messages in the draft message list

Precondition: You have opened the draft message list (page 41).

	Select SMS.
either ...	Reading SMS:
Read	Press the display key. Use  to view the continuation of the text message in the display.
or ...	Deleting an SMS:
Delete	Press the display key.

Deleting the entire draft message list

This function deletes all the messages in the draft message list.



Precondition: You have opened the draft message list (page 41).

 → **Delete Calls List**

Yes	Press the display key to confirm the prompt.
	Long press (back to idle status).

Sending or editing text messages in the draft message list

Precondition: You have opened a text message in the draft message list to read (page 42).

	Open the menu.
either ...	Writing and sending a new text message:
Write Message OK	Confirm. The input field is opened (page 38).
or ...	Editing and sending a stored text message:
 Use Text OK	Select the menu item and confirm. The input field is opened with the contents of the stored text message.

You can now send the message as described on page 39.



















Inserting standard text, pictures, sounds or email address in an SMS message

The options are:



- ◆ 3 templates: **I am late**, **Let's meet**, **Congratulations**,
- ◆ 15 pictures
- ◆ 10 sounds

You can also insert an email address that is stored in your email directory (page 29). Templates, pictures, sounds and email addresses are inserted where the cursor is.

Precondition: You are writing a text message (page 38) and the input field is open.

	Press the display key to open the menu.
either ...	Inserting a template:
 Insert Template 	Select the menu item and confirm.
 Let's meet 	Select template and confirm, e.g. Let's meet .
or ...	Inserting a picture:
 Insert Icon 	Select the menu item and confirm.
  	Select picture and confirm.
or ...	Inserting sounds:
 Insert Sound 	Select the menu item and confirm.
  	Select the sound and confirm.
or ...	Inserting an email address:
 Insert e-mail Adr. 	Select the menu item and confirm. This opens the email directory.
 Anna@... 	Select the address and confirm.

Receiving text messages and incoming message list

New text messages are indicated by the message "**You have new messages** ", by the message key  flashing on all handsets and by an advisory tone. The date and time (as received from the SMS Centre) are shown for each received SMS message.

In the incoming message list the new (unread) messages are shown before the old messages. New and old messages are sorted according to their time of arrival: oldest new message,... , newest message, oldest old message,..., newest old message.

Linked messages are displayed as **one** message (assuming your service provider supports text message linking). If an incoming linked message is too long or has not been transferred completely, it will be split into individual messages and stored in the incoming message list.

Opening the incoming message list

The **incoming message list** shows you:

- ◆ All received messages,
- ◆ Messages that could not be sent despite several attempts. These messages are all stored with an error status (page 53).



The message list is displayed for example as follows:

SMS: 01+05	Number of new entries in the list
	Number of old, read entries in the list
	Name of the general or personal mailbox

SMS (Text Messages)

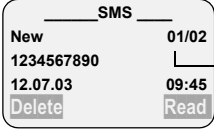

Opening with the message key

Precondition: There is at least one **new** message in the list.

		Press the message key.
 SMS: 01+05	OK	Select the mailbox (if necessary) and enter the mailbox PIN (page 48). The incoming message list is opened and the first new message is displayed.
		 <p>— Total number SMS — Serial number of the displayed SMS</p>



The display tells you if the message memory is full. Press **OK** to confirm and delete messages you no longer require from the incoming and draft message list.

Opening with the menu

		Open the menu.
SMS	OK	Confirm.
Mailbox	OK	Confirm. If more than one mailbox is activated (page 48), select a mailbox and confirm.
 OK		If required, enter the mailbox PIN and confirm.
 Incoming 01+05	OK	Select the menu item and confirm.

Reading and deleting text messages in the incoming message list

Precondition: You have opened the incoming message list (page 43).

		Select SMS.
either ...		Reading SMS:
Read		Press the display key. Use  to view the continuation of the text message in the display.
or ...		Deleting an individual SMS:
Delete		Press the display key. The next SMS is now displayed.
		Long press (back to idle status).

A new message which you have opened acquires the status **Old**.

Deleting the entire incoming message list

This function deletes **all new and old** text messages in the incoming message list.

Precondition: You have opened the incoming message list (page 43).



→ **Delete Calls List**

Yes	Press the display key to confirm the prompt.
	Long press (back to idle status).

Replying to or forwarding text messages

While you read a text message you can use the following functions:

	Press the display key to open the menu.
either ...	Replying to an incoming message:
Reply OK	Confirm. You can reply to the message immediately in the input field.
or ...	Answer "Yes":
Answer: Yes OK	Select the menu item and confirm.
or ...	Answer "No":
Answer: No OK	Select the menu item and confirm..
or ...	Edit the incoming message and return it:
Use Text OK	Select the menu item and confirm.
	Edit the text.
... then	
	Press the display key to open the menu.
Send OK	Confirm and then send the message as described on page 39.
or ...	
Save Entry OK	Select and confirm to store the entry.

To forward a text message, open the menu with and select the **Send** option. Now send the message as described on page 39.







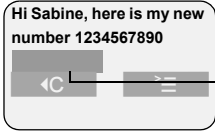

Attachments (e.g. screensavers, melodies) are not sent when you reply to an SMS message.

Attachments are however sent when you forward an SMS message. Some service providers do not allow the forwarding of SMS messages with attachments. In this case, select the function **Use Text** to forward the SMS without attachments. Confirm the prompt **New SMS will not contain picture/ melody. Proceed?**

Adding a telephone number from the SMS text to the directory

Your telephone "recognises" telephone numbers in a received SMS. It shows the number by highlighting it (maximum 32 digits). If the SMS text contains several numbers, the first one will be highlighted. While scrolling through the SMS text with , the next number will be highlighted automatically.

Precondition: You have opened the incoming message list and selected a message.





	<p>Press the display key.</p> 
	<p>Press the display key to open the menu.</p>
 <p>Copy to Directory </p>	<p>Select the menu item and confirm.</p>
 	<p>Scroll to the Name line and enter the name (max. 16 characters) (for text input see page 98).</p>
	<p>Press the display key to open the menu.</p>
<p>Save Entry </p>	<p>Confirm. The entry is stored.</p>
	<p>Long press (back to idle status).</p>

<p><i>i</i></p>	<p>The number has to be stored in the directory together with its area code (prefix) so that it can also be used for sending text messages.</p>
-----------------	---

Copying the telephone number of an SMS sender to the directory

Precondition: You have opened the incoming message list and selected a message.

 → **Copy to Directory**





 	<p>Scroll to the Name line and enter the name (max. 16 characters) (for text input see page 98).</p>
	<p>Press the display key to open the menu.</p>
<p>Save Entry </p>	<p>Confirm. The entry is stored.</p>
	<p>Long press (back to idle status).</p>

<p><i>i</i></p>	<ul style="list-style-type: none"> ◆ The number of the text message recipient has to be stored in the directory together with its area code (prefix) so that it can also be used for sending text messages. ◆ You can set up a special SMS directory within the ordinary directory by inserting a star (*) in front of the names of these entries.
-----------------	--

Marking text messages as "new"

If you wish to put an "old" text message (one which you have already read) back to the top of the incoming message list, you first have to mark it as "new". The  key on the handset will now flash. This will let others, e.g. members of your family, know that they have received a message.







Precondition: You have opened the incoming message list (page 43).

 	Select the SMS and open the menu.
Mark as New 	Confirm.
	Long press (back to idle status).

Opening the attachment of an SMS

The attachment is shown in angle brackets (e.g. <Screensaver>). For installation information see page 51.

Precondition: You have opened the incoming message list and selected an old message (page 43).

 Read 	Select SMS and press the display key.
	Move the cursor to where the attachment is.
	Press the display key to open the menu.
 View Content 	Select the menu item and confirm.
	Long press (back to idle status).

<i>i</i>	An SMS message can contain several attachments.
-----------------	---

Using several text message mailboxes

You can add three user-based "private" mailboxes to your phone, allowing up to three persons to have their own SMS mailbox. The options are:

- ◆ 1 general mailbox,
- ◆ 3 private mailboxes.

<i>i</i>	You can only use the personal mailboxes if your service provider supports the delivery of text messages to personal mailboxes. If necessary you should ask your service provider what you have to do when entering the SMS centre's numbers to use personal mailboxes.
-----------------	--

Open the SMS list with the message key. You will see:

- ◆ All the mailboxes that have been activated,
- ◆ All the mailboxes which contain at least one **new** message.

Access to private mailboxes can be protected with a **PIN** (4 digits). This is **not possible** with the general mailbox.

Setting up a personal mailbox

To be able to use several mailboxes, you have to activate each mailbox and assign it an "ID", which is a kind of extension number.

An SMS centre receiving a text message for your number with no mailbox ID will put it in your general mailbox.







If only the general mailbox is activated, all incoming text messages will be put in it even though they are sent with a mailbox ID.

If you wish to protect your mailbox you can assign it a PIN which you then have to enter before you can open it.

The general mailbox cannot be assigned a PIN. Only the general mailbox is activated when you purchase the phone. Its mailbox ID is "0". The general mailbox cannot be deactivated.

 → **SMS** → **Settings** → **SMS Mailboxes**

Activated mailboxes are marked ✓.

 Mailbox 2 OK	Select and confirm, e.g. Mailbox 2 . 
	Activating/deactivating the mailbox
	Turn on Activate.
	Scroll to the ID: line and enter a digit (ID) for your private mailbox (1–9). Already assigned digits will not be available.
	Scroll to the Protection: line and activate PIN protection.
	Scroll to the line PIN: and assign a PIN (4-digit).
Save or ... OK	Depending on the operating situation: Now press the display key to confirm the entry.

<i>i</i>	If you operate a number of devices (base stations) with SMS functionality on a single phone line, then each SMS mailbox ID may only occur once. In this case you also have to change the preset ID of the general mailbox.
-----------------	--

To find out how to change the PIN, turn to page 49. If you have forgotten your PIN, you can reset it by restoring the factory settings of the base station. This will **delete all messages from all mailboxes**.

If you deactivate a mailbox (in the line **Call Director:** line set **Off**), messages sent to that box will be lost. The messages stored for that box are deleted.

If you deactivate the PIN protection, the PIN is reset to 0000.

Sending a text message to a personal mailbox

To send a text message to your personal mailbox, the sender has to know your ID and enter it after your number. Send your SMS contact a text message. Your SMS telephone number with the current ID will be sent automatically. The recipient can then store it in his or her directory.











<i>i</i>	<ul style="list-style-type: none"> ◆ The message will not be delivered if the sender has used an invalid ID or the mailbox has been deactivated. ◆ The message will go to your general mailbox if the sender has not entered the ID.
----------	---

Changing the ID, name and PIN of a mailbox

You can change the PIN by overwriting the current entry. You cannot change the name of the general mailbox.

 → **SMS** → **Settings** → **SMS Mailboxes**

Activated mailboxes are marked ✓.

either ...	Changing the name of the mailbox:
 Edit	Select the mailbox and press the display key.
 Save	Now enter the new name and press the display key to store the entry.
or ...	Changing mailbox ID and PIN:
 Mailbox 2 OK	Select and confirm, e.g. Mailbox 2 .
 OK	If required, enter the mailbox PIN and confirm.
 	Scroll to the ID: line and select a new ID.
 	Scroll to the Protection: line and activate or deactivate PIN protection.
 	Scroll to the PIN line (you will see the current PIN) and overwrite the PIN (4-digit).
Save	Now press the display key to confirm the entry.
	Long press (back to idle status).

<i>i</i>	The general mailbox cannot be PIN protected.
----------	---



Notification by SMS

You can have a notification sent to any device with SMS functionality, e.g. your mobile phone, by SMS. You first have to store the destination number in your phone which is at home (factory setting: Off).

Precondition: The caller's number was identified when a call was missed (CLI).

Storing the notify number

 → **SMS** → **Settings** → **Notify Number**



	Enter the number (e.g. of your mobile phone) and press the display key.
Save Entry 	Confirm. The entry is stored.
	Long press (back to idle status).

Setting the notify type

You can select which calls will be notified:

- ◆ Missed calls from the calls list and/or
- ◆ Messages from the answering machine (SL 150 only).

 → **SMS** → **Settings** → **Notify Type**

either ...	Activating/deactivating missed calls:
	In the line Missed Calls: select On or Off .
or ...	Activating/deactivating messages from the answering machine:
	Scroll to the Ans Machine: line and select On or Off .
Save	Now press the display key to store the setting.
	Long press (back to idle status).

i	If Greek or Russian is set as the display language on your handset, you will be notified in English.
----------	--

Using new ringer tones and screensavers for handsets

You can load other melodies than those available in the handset and also a screensaver (picture). Melodies and screensavers are available on the Internet at www.my-siemens.com/ringtones (melodies) and www.my-siemens.com/logos (screensavers). Which data is available in your country is shown on the Internet pages. Ask your service provider whether it supports the downloading of screensavers and melodies via SMS.

You can use the following formats:

- ◆ "iMelody" for melodies
- ◆ Large Picture (32*32) and Small Picture (16*16) for screensavers.

Once you have ordered the loading of melodies and/or screensavers, you will receive one or more **SMS messages** (in the incoming message list, page 43) with the corresponding data.

<i>i</i>	Loading data will incur a charge. Please ask your service provider.
-----------------	---

You can load **up to five new melodies**. The **new melody** will replace one of the ten melodies in the handset, namely melodies 6–10.



The **screensaver** replaces the idle state display (page 14), which may then conceal the date, time and name. You can load **only one** screensaver.

The screensaver may temporarily disappear if:

- ◆ You press any key,
- ◆ There is a low battery, appointment, reminder or alarm call tone,
- ◆ You remove or return the handset from or to the base station/charging unit.

Loading a new ringer tone or screensaver

You will now see **You have new messages**  in the display.

	Press the key to open the incoming messages list (page 43). The first new SMS is now displayed.
	Scroll to another text message if necessary.
Read	Press the display key. You can tell from the title or icon that you have been sent data for loading the melody/screensaver you selected. You will hear the new melody or see a preview of the new logo.
	If you like the melody or logo:
Install	Press the display key to start the loading process.
Yes	Press the display key to load the new melody or screensaver.
	For a new melody: Select the number of the old ringer melody you want to replace with the new one. As a precaution you will hear the old ringer melody.
OK	Confirm.

SMS (Text Messages)

If you do not like the melody or logo, after **Install** press **No**. The loading process will be terminated.

<i>i</i>	<ul style="list-style-type: none">◆ After loading, the melody or logo will remain in the incoming SMS list until you delete it by pressing the display key Delete (page 44).◆ You can also load the melody or screensaver from other handsets registered at the same base station.◆ How to open a screensaver or melody sent as an SMS attachment is explained on page 47.
----------	---

Activating/deactivating a screensaver



→ **Settings**

	Screen Picture	<input type="checkbox"/> OK	Select and confirm to activate or deactivate the screensaver (✓ = On).
			Long press (back to idle status).

<i>i</i>	<p>The screensaver is not displayed:</p> <ul style="list-style-type: none">◆ During a call,◆ When the room monitor or Walk and Talk function is activated,◆ If you have just received an SMS or a message on the answering machine(SL 150 only) ,◆ If the handset is de-registered.
----------	--

Text messages to a PABX

You can only receive a text message when the Calling Line Identification is forwarded to the extension of the PABX (CLIP).

The CLIP of the number of the SMS centre is evaluated in the **Gigaset** (telephone).

If your phone is connected to a PABX, you may have to prefix the number of the SMS centre with an access code (this depends on your PABX). You can store the access code in your base station (page 91).

If in doubt, you can test your PABX by sending a text message to your own number and putting the access code before the number of the SMS centre. If you do not receive the message, send another one, this time without the access code.

When you send messages, your sender number may be sent without your extension number. The recipient cannot reply to you directly in this case.

Text messages can only be sent and received **through ISDN exchanges** with the MSN number assigned to your base station.

Errors when sending and receiving a text message

Errors when sending a text message

The following error codes are displayed:

Error Code	Description
E0	Calling Line Identification permanently withheld (CLIR). Calling Line Identification is not enabled.
FE	Error occurred during message transfer.
FD	Connection to SMS centre failed. Text messages cannot be sent or received if the number of an SMS centre is missing or incorrectly stored. Check that the number of the SMS centre has been correctly stored.

Errors when receiving a text message

A message appears on the screen if your phone cannot receive any more text messages. You **cannot** receive text messages under the following conditions:

- ◆ The CLIP service (Calling Line Identification Presentation) is not activated for your phone line,
- ◆ Call diversion is activated with **When: All Calls** ,
- ◆ Call diversion **All Calls** is activated for the network mailbox,
- ◆ The memory (incoming and draft message lists) is full.

Self-help with error messages

Error Message	Possible Cause	Remedy
You cannot send messages.	You have not requested the CLIP service (Calling Line Identification Presentation).	Ask for this service to be enabled.
	Message transfer was interrupted (e.g. by a call).	Re-send the message.
	No number or an invalid number is entered for the SMS centre activated as the send centre.	Enter the telephone number.
You receive a message whose text is incomplete.	Your phone's memory is full. The provider has not yet sent the rest of the message.	Delete some old messages (page 44).
You have stopped receiving messages.	You have changed the ID of your mailbox.	Tell your SMS contacts your new ID or undo the change (page 49).
You receive no messages.	You have not activated your mailbox.	Activate your mailbox (page 49).
The message is played back.	The "display call number" service is not activated.	Ask your network provider to activate this service (there is a charge for this).
	Your terminal is stored in the database of your SMS provider as having no fixed network SMS functionality, i.e. you are no longer registered in it.	Register the terminal (again) for SMS reception.
Messages are only received during the day.	If your SMS network provider's database does not yet know that your terminal supports fixed network SMS functionality, then it will only attempt to deliver messages during the day.	Register the terminal (again) for SMS reception to get it re-assigned in the database.

Using the answering machine in the SL 150

Base station

The Gigaset SL 150 has an integrated answering machine. It records calls once it has been activated (factory setting). You can operate the answering machine:

- ◆ via the handset (with voice prompts if available),
- ◆ from the remote control (with voice prompts if available).

The date and time of arrival of each message is logged if you have previously set this function (page 15).

You can add up to **three mailboxes** to the answering machine. This enables several users to each have their "own" personal answering machine. The announcement on the answering machine is always the same for **all mailboxes**.

As well as the integrated answering machine, you can also select an answering machine of your network provider (e.g. Deutsche Telekom's network mailbox).



Message	Message that a caller leaves on the answering machine.
Memos	"Spoken notes" that you can record on the answering machine for members of your family or office colleagues, for example.
Announcement mode	Recording or announcement.
Answer and record mode	The caller hears a pre-recorded or personal announcement and may then leave a message.
Announce mode	The caller hears your announcement but cannot leave a message.
Pre-recorded announcement	A preset announcement (standard text).
Personal announcement	An announcement you record in your own words.

Operating the answering machine via the handset

The handset's loudspeaker activates **automatically** if you receive an acoustic prompt or message while operating the answering machine from the handset. Use the talk key  to switch the handsfree mode off.

Switching the answering machine on/off

Note: The answering machine uses the standard announcement stored until you record your own announcement.

1.  → Answer Machine → Ans Machine: In the line **On/Off**: activate or deactivate the answering machine →  press the display key to save the setting.
2. After activating the answering machine, it will tell you how much memory time is left. The  icon appears in the display.

Extending the answering machine to three mailboxes

If you want to use several mailboxes, activate the **answering machine and enter the number of mailboxes** for recording incoming calls.

A caller will then hear your announcement saying which internal user has which mailbox number (1, 2 or 3). Please bear in mind that you can only record **one** announcement for the answering machine regardless of how many mailboxes you have activated.



Using the answering machine in the SL 150 Base station

Example for an announcement: "This is the answering machine of the Smith family. If you want to leave a message for Rosy Smith, press 1, for Paul Smith press 2."

The caller will then enter the appropriate **number of the mailbox** he or she wants to leave a message in.

If the caller enters an incorrect mailbox number or the selected mailbox has not been set up, the incoming message will automatically be left in mailbox 1.

 → **Answer Machine** → **Ans Machine**

	In the On/Off: line activate or deactivate the answering machine.
 	Scroll to the Mailboxes: line and enter the number of mailboxes (1–3) you want to use for recording messages. Example: Entering "1" activates mailbox 1. Entering "2" activates two mailboxes (1 and 2), "3" activates three mailboxes (1, 2 and 3).
Save	Now press the display key to confirm the setting.

Changing the number of mailboxes

To do this:



1.  → **Answer Machine** → **Ans Machine**
2. When you try to change the number of activated mailboxes, you will be prompted to delete all the messages first (see page 61). After this, you will be asked whether you want to change the announcement for the answering machine.
3. Then change the number of mailboxes by repeating from step 1.

Recording a personal announcement/announce only message

 → Answer Machine → Announcements



either ...		Recording a personal announcement:
Rec Announce	OK	Confirm.
or ...		Recording an announce only message:
 Rec Anc Only	OK	Select the menu item and confirm.
... then		The display prompts you to start recording:
OK		Confirm. You hear the ready tone (a short tone). Now record your announcement.
End		Press the display key. The recorded announcement is repeated for you to check.

Please remember:

- ◆ Recording ends automatically when the max. recording time of 170 seconds is exceeded or there was a break in speaking of more than 2 seconds.
- ◆ During recording you can cancel the announcement with the  key or  and re-record it with the display key **OK**.
- ◆ If you cancel while recording, the following will happen automatically:
 - in **Answer and Record** mode, the pre-recorded announcement will be used again,
 - in **Announce Only** mode the answering machine is deactivated.

Playing the announcement



 → Answer Machine → Announcements

either ...		Playing the personal announcement:
 Play Announce	OK	Select the menu item and confirm.
or ...		Playing the announce only message:
 Play Anc Only	OK	Select the menu item and confirm.

i

While playing the announcements press display key **New** if you want to record it again.

Deleting announcements/messages

- ◆  → Answer Machine → Announcements → **Del Announce** → Press the display key to confirm the prompt.
- ◆  → Answer Machine → Announcements → **Del Anc Only** → Press the display key to confirm the prompt.





Select announcement mode

You can choose between **Ans. & Record** mode and **Announce Only** mode (if you have recorded the announce only message, page 57). For definitions of the terms see page 55.

You can add the **Ans Mode Time** function to either of the options.

There is a pre-recorded announcement stored in your phone for the Answer and Record mode. This announcement is used if you have not yet recorded a personal announcement or if a personal announcement has been deleted.

 → **Answer Machine** → **Announcements** → **Set Ans. Mode**















either ...		With Answer and Record message:
Ans. & Record		Confirm (✓ = On).
or ...		No Answer and Record message:
 Announce Only		Select the menu item and confirm (✓ = On). Your selected announcement is saved even after the answering machine is deactivated.
		Long press (back to idle status).

Setting alternate between answer and record and announce only

Example: You have set the answer and record mode. Now select the period during which answer and record is to switch to announce only, e.g. from 6 p.m. to 8 a.m. In the period from 8.01 a.m. to 5.59 p.m., the answering machine automatically switches back to the answer and record mode you set.

Precondition: You have set the time (page 15).

 → **Answer Machine** → **Announcements** → **Set Ans. Mode** → **Ans Mode Time**

		Entering and activating the time for "Ans Mode Time":
		In the From: line enter the start of the period, e.g.     for 8.00 a.m.
 		Scroll to the Until: line and enter the end of the period, e.g.    for 5.00 p.m.
 		Scroll to the On/Off: line to activate the switch to Announce Only (in so far as the announce mode- Ans. & Record is activated or vice versa).
		Now press the display key to confirm the entry.

If you have selected the 12-hour display, you can use display key **am/pm** to toggle to the other half of the day.

<i>i</i>	<ul style="list-style-type: none">◆ Selecting a different announce mode or deleting the announce only message automatically deactivates the Ans Mode Time function.◆ If the memory is full in Ans. & Record mode, the answering machine will react as follows:<ul style="list-style-type: none">– if there is an announce only message (page 57), the answering machine will automatically switch to Announce Only mode– If there is no announcement, it switches itself off. Then delete the old messages. The answering machine automatically returns to the original mode when the old messages have been deleted.
----------	--

How the answering machine responds to the deletion of announcements

Announcement mode **Ans. & Record**: The answering machine remains activated after the personal announcement is deleted. The pre-recorded announcement is used.

Announce Only mode: The answering machine deactivates after the announce only message is deleted.

"Ans Mode Time": setting

- ◆ The answering machine remains activated after the **personal announcement** is deleted. The pre-recorded announcement is used.
- ◆ Deleting the **announce only message** deactivates the "alternate answer and record and announce only" setting:
 - The answering machine will remain in "answer and record" mode all the time if the **On/Off: Announce Only** line has been set.
 - The answering machine deactivates itself.

Playing messages





The date and time of arrival of each message is logged (provided this function is set, page 15). If Calling Line Identification is activated, then the caller's number or name is displayed.



New messages that have not yet been played are indicated by a message in the display and by the  key flashing on the handset.

Pressing  starts the playback with the first new message. After the last new message, the old messages are played back. You now hear the end tone.







Once they have been played, new messages are added to the list after the old ones.

If you want to replay messages you have already listened to, you have to select the answering machine list.

		Open calls list/answering machine list.
	Ans M.: 01+02 	Select the menu item and confirm. The loudspeaker activates. The playback starts.
	or ...	If several mailboxes have been activated:
	Mailbox 2 	Select and confirm, e.g. mailbox 2.

i	<p>If several mailboxes have been activated: If you notice after pressing the  key that "your" answering machine does not have any new messages but that of members of your family/your office colleagues does, leave the menu again. The  key will continue flashing, letting members of your family/your office colleagues know that they have received new messages.</p>
----------	--

Stop and skip forward/back during playback



either ...	1. Using the keypad:
	Stopping playback:
	Stop playback.
	Confirm to continue.
	Skipping forward and back:
	To the start of the current message.
2 x 	To the previous message.
	To the next message.
2 x 	To the next message but one.
or ...	2. Using voice prompts (page 63):
	Press.

You hear the ready tone (a short tone). Now speak the command **Back** or **Forward** (page 63).

i	The answering machine reverts to idle status if playback is interrupted for more than a minute.
----------	---







Marking a message as "new" during playback

If you wish to put an "old" message (one which you have already listened to) back to the top of the list, you first have to mark it as "new" **during playback**. The  key on the handset will now flash.

		Open the menu.
	Mark as New 	Select the menu item and confirm.

Adding the telephone number of a message to the directory

During playback:

		Open the menu.
	Copy to Directory 	Select the menu item and confirm.
		Enter name (for text input see page 98).
		Press the display key to open the menu.
Save Entry 		Confirm. The entry is stored.

Deleting messages

You can delete old messages either all together or individually. You have to listen to a message for at least 3 seconds before its status changes to "old" and it can be deleted. If you have activated several mailboxes, only the messages on the currently selected one will be deleted.



Deleting all old messages

During playback or pause:  → **Del All Old Msgs**

	Press the display key to confirm the prompt.
---	--

Deleting individual old messages

While playing back the message to be deleted:

either ...	1. Using the keypad:
	Press the display key.
or ...	2. Using voice prompts (page 63):
	Press. The loudspeaker activates.

The loudspeaker activates. You hear the ready tone (a short tone). Now speak the command **Delete**. You will hear the ready tone again when prompted to repeat the command. Repeat **Delete** (page 63).

Recording memos

Memos are played back and deleted in the same way as messages. New memos are signalled by a flashing  key on the handset. You can record a number of memos. If you have activated several mailboxes (page 55), you also have to specify the mailbox for which you want to save the memo.







 → **Answer Machine** → **Record Memo**

		If several mailboxes have been activated:
 Mailbox 2	OK	Select a mailbox and confirm.
press "OK"	OK	Confirm. You hear the ready tone (a short tone). Now record your memo.
End		Press the display key.

If during recording you press key  or , the recording will be cancelled, and the memo will be lost.

Adding a telephone number from the answering machine list to the directory

 → **Ans M.: 01+02**

		If several mailboxes have been activated:
 Mailbox 2	OK	Select a mailbox and confirm.
 		Select an entry and open the menu.
 Copy to Directory	OK	Select the menu item and confirm.
		Enter name (for text input see page 98).
		Press the display key to open the menu.
Save Entry	OK	Confirm. The entry is stored.
		Long press (back to idle status).

Picking up a call from the answering machine





While the answering machine is recording a call, you can pick it up by pressing the talk key .

Recording stops and you can speak to the caller. If 2 seconds of the call have already been recorded when you pick it up, the call will be displayed as a new message. The  key flashes when the call ends.

Activating/deactivating Two-Way Recording

You can record an **external** call with the answering machine. The recording time depends on the selected recording quality (page 66) and the amount of available memory.

Tell the other party that the call is being recorded.

		Open the menu.
	either ...	Activating two-way record:
	Two Way Record 	Select the menu item and confirm.
		If several mailboxes have been activated:
	Mailbox 2 	Select the menu item and confirm.

Two-way recording is indicated by an advisory text in the display and it is added to the message list as a new message.

To stop two-way recording, press display key **End**.

Operating the answering machine with voice prompts



You can use voice commands to control message playback. Four different users can save their pronunciation of the commands **Delete**, **Continue** and **Go Back** for voice recognition. For the recording, the user has to speak **all three voice patterns** in the above order.

With activated voice control (page 64), you can then control the answering machine via the handset and also away from home or the office (remote operation, see page 64) using the voice commands.

Recording voice commands

Record your voice pattern in quiet surroundings.

 → **Answer Machine** → **Voice Prompts** → **Record Command**

	User 2 	Select a user and confirm.
		Confirm.



The loudspeaker activates. You will hear the ready tone (a short tone) when prompted to speak the first command. Now speak the command **Delete**. You will hear the ready tone again when prompted to repeat the command. Repeat **Delete**.

You are now prompted to speak the second command **Forward**. Proceed exactly as you did for the **Delete** command. Finally, speak the third command **Back**.

<i>i</i>	Once the answering machine's memory is full, you cannot record any more voice patterns.
-----------------	---

Changing the user name

 → Answer Machine → Voice Prompts → Record Command

 User 2	Select a user.
Edit	Press the display key.
 Save	Enter the name and press the display key.

Activating/deactivating voice prompts

Precondition: You have recorded voice commands.

 → Answer Machine → Voice Prompts

 Ans Machine OK	Select the menu item and confirm (✓ = On).
--	--



Operating the answering machine while you are away from home (remote operation)

You can check and activate your answering machine from any other telephone (hotel, pay phone etc.). You will find a quick guide for remote operation on page 98.

Precondition:

1. You have previously changed the preset system PIN (0000) **at home** (page 87).
2. The phone from which you are calling has tone dialling (DTMF), i. e. you hear different tones when you press the keys. Alternatively you can use a code transmitter (available from your mobile phone retailer).

Calling your answering machine and playing messages

	Dial your own telephone number.
	While you are listening to your announcement:
	Press the 9 key and enter your system PIN.
	If several mailboxes have been activated:
	Press the hash key and enter the number of the mailbox. You are connected to "your" mailbox.

The answering machine tells you whether any new messages have been recorded. The messages are now played back. You can remote operate your answering machine in one of two ways:

- ◆ with the keypad,
- ◆ with voice prompts.

Operating the answering machine with the keypad

Key the appropriate digit for the required action.

Digit	Meaning
1	Go to the start of the current message. Go to previous messages (press repeatedly).
2	Stop. Press again to resume.
3	Go to the next message. Go to the next messages (press repeatedly).
*	Mark a message as "new".
0	Delete the current message.
# 3	Go to a mailbox, e.g. mailbox 3.

Operating the answering machine with voice prompts



Before each voice command, press **9** and then speak the command when you hear the ready tone. When you delete a message you are prompted to repeat the command. Repeat "**Delete**" (without pressing **9** first).

Precondition: You have first activated the voice prompts (page 64).

Activating the answering machine remotely

If you have forgotten to activate your answering machine you can activate it remotely. Call your own number with a mobile phone or tone dialling phone and let the number ring for about one minute. You will hear: "Please enter PIN".

Precondition: The system PIN must not be 0000 (page 87).

	Enter system PIN.
	If several mailboxes have been activated:
	Also enter the mailbox number.

Your answering machine is activated. It tells you how much memory time is left. If several mailboxes have been activated, you will be prompted to enter the number of the mailbox you want to listen to. The messages are now played back.

i	The answering machine cannot be deactivated remotely.
----------	--

Setting the answering machine of the SL 150 Base station

The answering machine has already been preset at the factory. However you can make individual settings using the handset.

Ring delay and charge saving function for remote operation

You can set when you want the answering machine to activate. The options are: **0 sec.**, after **10 sec.**, **20 sec.** (factory setting) or **30 sec.** Instead of a fixed ring delay you can also use the **charge-saving** setting **Auto**. In this setting the answering machine activates **automatically**:

- ◆ after 10 seconds if there are new messages;
- ◆ after 20 seconds if there are no new messages.

After around 15 seconds in remote operation you will know that there are no new messages (otherwise the answering machine would have already activated). There will be no call charges if you hang up now.

Please remember:

- ◆ Only ringer melodies 1-3 are the same as the call tones during a call.

With all ringer tones **the first ringer tone is suppressed**. You can cancel the suppression of the first ringer tone (page 84).

 → **Answer Machine** → **Ring Delay**



	Select a ring delay (0 sec. , 10 sec. , 20 sec. , 30 sec. , Auto).
Save	Now press the display key to confirm the setting.

Setting the recording time and recording quality

You can set the maximum length of a message and its recording quality. The recording quality determines the total recording time of your answering machine.

The total recording time is up to 9 minutes in the **High Quality** setting and up to 15 minutes in the **Long Play** setting.

 → **Answer Machine** → **Message Set** → **Message Length**





either ...	
	Select recording time (30 , 60 , 120 sec. or Maximum).
or ...	
 Record Quality OK	Select the menu item and confirm.
	Select Long Play or High Quality .
... then	
Save	Now press the display key to store the setting.

Activating/deactivating call screening

While a message is being recorded, you can listen to it via the loudspeaker of any handset (factory setting).

 → **Answer Machine** → **Call Screening**



Handset	OK	Confirm (✓ = On).
		Long press (back to idle status).

i	<ul style="list-style-type: none"> ◆ The handsfree key  is illuminated during recording. You can accept the call by pressing the talk key , the display key Accept or the handsfree key . ◆ You can switch off the Call Screening function on the handset during the call using the "end call" key .
----------	--

Resetting fast access on the answering machine

The (integrated) answering machine is preconfigured for fast access at the factory. However, if you have set the network mailbox for fast access (see page 68) you can reset this setting.

 → **Answer Machine** → **Set Key 1**

	Answer Machine	OK	Select the menu item and confirm.
			Long press (back to idle status).

Once you have selected the answering machine or network mailbox, simply **hold down** the  key. You will then be connected directly.

If you have activated **several mailboxes**, enter the number of the mailbox you want to listen to after pressing the  key.

The setting for fast access applies to all registered handsets.

Using the network mailbox

The "T-NetBox" network mailbox is the answering machine in your network provider's network ("T-Net"). You cannot use the network mailbox unless you have **applied** to your network provider.

Configuring the network mailbox for fast access







When fast access is configured, by pressing and holding the  key you can either select the network -mailbox or the integrated answering machine (Gigaset SL 150) directly.

With the **Gigaset SL 100** the network mailbox is preconfigured for fast access. You just need to enter the number of the network mailbox.

With the **Gigaset SL 150** the (integrated) answering machine is preconfigured for fast access. You can configure the network mailbox instead. Ask your network provider about this.



Entering the network mailbox number and configuring the network mailbox for fast access

 → Answer Machine → Set Key 1

Network Mailb.		Confirm (✓ = On).
  		Enter the telephone number of the mailbox and press the display key.
Save Entry		Confirm. The entry is stored.
		Long press (back to idle status).

This setting is now valid for all registered handsets. To find out how to reset fast access on the Gigaset SL 150 to the answering machine, refer to page 67.

Calling the network mailbox

Press  **and hold**. This connects you directly to the network mailbox. If you now press the handsfree key,  you can "open listen" to the announcements of the network mailbox and operate the network mailbox easily and conveniently.

Viewing a message from the network mailbox

When a message arrives for you, you get a call from the network mailbox. If you have requested Calling Line Identification, the display shows the number. If you accept the call, the new messages are played back. If you do not accept the call, the number of the -network mailbox will be stored in the list of missed calls and the message key flashes (see page 31).

Registering and de-registering handsets

You can register up to six handsets on your base station.



An SL 1 handset can be registered on up to four base stations.

Manual registration: Gigaset SL 1 to Gigaset SL 100 or SL 150

You have to initiate handset registration on the handset and on the base station.

1. On the handset

 → **Settings** → **Register H/Set**

	Base 1	OK	Select base station (1–4) and confirm, e.g. Base 1 .
	OK	Enter the system PIN (the factory setting: 0000) and confirm.	

Base 1 flashes in the display when the system PIN has been entered.

2. On the base station

	Press the registration/paging key on the base station for 3 seconds. Registration is initiated.
---	---

The base station search is cancelled after 60 seconds. If registration has not completed inside this time, repeat the process.

After successful registration, the handset will be assigned the lowest free number.

Manual registration: Gigaset 1000 to 4000 and other handsets with GAP functionality

This section describes how to connect handsets belonging to the Gigaset families, handsets A 2, C 1, S 1 or handsets of other devices with GAP functionality to your SL 100/SL 150.

1. On the handset

Start to register the handset as described in its operating instructions.

2. On the base station







	Press the registration/paging key on the base station for 3 seconds. Registration is initiated.
---	---

The next unassigned internal number (1-6) is automatically assigned to the handset as it is registered. If all the numbers have been assigned, number 6 is overwritten provided the handset is in idle status.

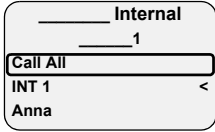
Registering and de-registering handsets



De-registering handsets

You can de-register any registered handset from any registered SL 1 handset.

	Open list of handsets. 	The handset you are using is marked with <.
	Select the handset you wish to de-register (your own handset is marked with <) and open the menu.	
 De-reg. H/Set No. 	Select the menu item and confirm.	
 	Enter the current system PIN (the factory setting is 0000) and confirm.	
	Press the display key to confirm the prompt.	

Looking for a handset ("Paging")

If you have mislaid your handset you can "page" it with the help of the base station. The registration/paging key is on front of the base station.



	Press the registration/paging key on the base station for 1 second. All handsets will ring at the same time ("Paging").	
	End paging:	
	Press the registration/paging key on the base station again for 1 second or the talk key  .	

Changing the base station

The following settings may be made if your handset is registered with more than one base station:

- ◆ Set to one specific base station, e. g. the base station at home or the base station at the office.
- ◆ Set to the base station with the best reception **Best Base**. This setting will automatically select whichever base station has the best reception.

 → **Settings** → **Select Base**







 	Select one of the registered base stations or Best Base and confirm.	
---	---	--



Using several handsets

Internal calls, ending a call

Internal calls are calls with other handsets that are registered with the same base station. These calls are free.



Calling a specific handset or all handsets simultaneously.

	Open list of handsets. Your own handset is marked with .
either ...	Call a specific handset:
	Select the handset and press the talk key or enter the number of the handset, e. g.   .
or ...	Call all handsets ("group call"):
	Press the star key. All handsets are called.
... then	End the call:
	Press the end call key.

i	To call a specific handset, you can also enter the handset number after you open the list, e.g.   .
----------	---

Changing the name of a handset







The names "INT 1", "INT 2" etc. are assigned automatically. However you can change these names, e. g. to "Anna" etc. (10 characters maximum). The changed name is displayed in the list of every handset.

	Open list of handsets.
	Select the handset and press the display key.
	Enter the name and press the display key (for text input see page 98).

Using several handsets

Changing a handset's internal number



A handset is **automatically** assigned the lowest unassigned number when it is registered. You can change the internal number of all registered handsets (1–6).

	Open list of handsets
	Open the menu.
Edit H/Set No. 	Confirm. The list of handsets is displayed.
 	The current number flashes. Select the handset, enter the new internal number (1–6) and confirm. The handset's old number is overwritten.
Save	Now press the display key to confirm the entry.
	Long press (back to idle status).

i	You will hear the error tone if you assign an internal number twice (a falling tone sequence). Repeat the process with an unused number.
----------	--

Transferring a call to another handset



You can transfer (connect) an external call to another handset.

	Open list of handsets. The external caller hears the wait melody.
 OK	Select the handset or Call All and confirm. When the internal user answers, announce the external call.
	Press the end call key. The external call is transferred to the other handset.

i	Instead of announcing the call you can also press the "end call" key  immediately. If the internal user does not answer or is busy, the call will come back to you automatically (Recall appears in the display).
----------	---

Internal enquiry calls

You can call an **internal** user (e.g. to consult with him or her) while speaking with an **external** caller. You are automatically reconnected to the external user when you end this internal call.

	Open list of handsets. The external caller hears the wait melody.
 OK	Select the handset and confirm.
	Ending a enquiry call:
End	Press the display key. You are reconnected to the external caller.

Accepting/rejecting call waiting during an internal call

If you get an external call while conducting an **internal** call, you will hear the call waiting tone (short tone). The caller's number or name will appear in the display if Calling Line Identification is enabled. If you reject the call waiting tone on your handset, it can still be heard on other registered handsets.

either ...	Cancelling internal call, accepting external call:
Accept	Press the display key. The internal call is ended . You are connected to the external caller.
or ...	Reject external call:
Reject	Press the display key. The call waiting tone is deactivated. You are still connected to the internal caller.

Listening in to an external call



You are conducting an external call. An internal party can listen in to this call and can speak as well. A signal tone indicates "listening in" to all call parties.

Precondition: The **Listening In** function is activated (factory setting: Off).

Activating/deactivating "internal listening in"





→ **Base Settings** → **Add. Features** → **Listening In**

 OK	Enter the system PIN (page 87) and confirm (✓ = On).
	Long press (back to idle status).

Internal listening in

On your handset you see **In use**. You wish to listen in to this external call.

	Press the talk key. You can now listen in to the call. All parties hear a signal tone.
	Ending listening in:
	Press the end call key (signal tone).

i	If the first internal party presses the "end call" key  , a signal tone sounds. The handset that is "listening in" is still connected to the external party however.
----------	---

Call Director (calling a specific handset) (SL 150 only)

You can set your phone so that an external caller is put through direct to a specific handset. You have to activate the Call Director for this. When he has dialled your number, the caller is asked to select the number of the person he wishes to speak to, or he hears your personal Call Director announcement. He now has 5 seconds to dial the internal number of the required handset.

Precondition: The Call Director has been activated.

i	If the dialled party does not take the call, the answering machine will accept it provided it is switched on. If the ring delay of the answering machine is set to 0 sec. (page 66), then the call director announcement will not be played.
----------	---

Activating/deactivating the Call Director (SL 150 only)



 → **Base Settings** → **Call Director**

Call Director	OK	Confirm to activate or deactivate the Call Director (✓ = On).
		Long press (back to idle status).

Recording a Call Director announcement (SL 150 only)



Here is a typical Call Director announcement: *"To speak to Mr. Jones press 1, to speak to the secretary press 2. If you do not want to speak to anyone in particular, press the >star< key"*.

 → **Base Settings** → **Call Director**

 Rec Announce	OK	Select the menu item and confirm. The display prompts you to start recording.
OK		Confirm. You hear the ready tone (a short tone). Now record your announcement. If during recording you press  or the end call key  , the recording is cancelled. Recording ends when the max. recording time of 170 seconds is exceeded or there was a break in speech of more than 2 seconds.
End		Press the display key. The recorded text is repeated for you to check.

Playing/deleting (SL 150 only) a Call Director announcement

 → Base Settings → Call Director

either ...	Play the announcement:
 Play Announcement <input type="button" value="OK"/>	Select the menu item and confirm.
or ...	Deleting the announcement:
 Del Announcement <input type="button" value="OK"/>	Select the menu item and confirm.
<input type="button" value="Yes"/>	Press the display key to confirm the prompt.
	Long press (back to idle status).

<i>i</i>	<ul style="list-style-type: none"> ◆ If you want, you can switch the loudspeaker on during playback by pressing the  key. ◆ While playing the announcement, press display key New if you want to record it again.
----------	---

Picking up a call (SL 150 only)

If the call is not taken at the called handset when Call Director is activated, you can pick it up at another handset by pressing the talk key . The call is only visually indicated at that handset.

Using a handset as a room monitor

With this function, a previously stored internal or external number is called when a set noise level in the room is reached (the baby cries). When you answer the call you hear the noise in the baby's room. The room monitor **remains activated** on the handset even after you hang up.

The handset should be between 1 and 2 metres away from the baby. The microphone must be directed towards the baby.

When the room monitor is activated, incoming calls to the handset which is near the baby are indicated **without a ring tone**, they are just shown on the display. The display and the key pad are not illuminated.

When entering an external telephone number, make sure:









- ◆ The handset in the baby's room is **not barred** for outgoing calls.
- ◆ The number to which the alarm calls is sent is not blocked by an activated answering machine.

	Always check the settings of the room monitor before you leave home, e.g. sensitivity and phone line.
---	--



Using several handsets

<i>i</i>	<ul style="list-style-type: none"> ◆ If you redirect your room monitor to an external number, then you should tell that number's owner. ◆ The room monitor's call to an external phone number stops after about 90 seconds, to an internal number (handset) it stops after about 180 seconds (depending on the base station). ◆ The room monitor function severely curtails the handset's operating time. You can leave the handset in the baby's room in the charging unit. This will avoid the battery going flat. ◆ The room monitor function can also be used in Walk and Talk mode.
----------	--

Activating the room monitor function and entering the "call to" number for the first time





		Step 1: Open the entry field for the room monitor:
		Open the menu.
 Add. Features	OK	Select the menu item and confirm.
Room Monitor	OK	Confirm. The input field is opened.
		Step 2: Activate the room monitor:
		In the line Room M.: select On .
		Step 3: Enter the telephone number:
 Edit		Scroll to the Call to: line and press the display key. The input field for the telephone number is opened.
either ...		Enter an internal number as the "call to" number:
INT		Press the display key.
 OK		Select the handset and confirm.
or ...		Enter an external number as the "call to" number:
		Enter the telephone number.
		Press the display key.
Save Entry	OK	Confirm. The entry is stored.
		Step 4: Set the sensitivity:
 		You can scroll to the Level: line if you want to set the sensitivity for the noise level (Low or High).
Save		Press the display key. The room monitor function is now activated.

Once the room monitor is activated, switch directly to the room monitor setting with  (open menu).

<i>i</i>	<ul style="list-style-type: none"> ◆ If you want to copy the external telephone number from the directory, while in the entry field for the telephone number press the bottom of the control key  (open directory). Now select an entry with  and confirm with OK. ◆ If you enter an external number as the "call to" number, only the last 4 digits will appear in the input panel.
----------	---

Changing an external "call to" number





Precondition: You are in the entry field for the room monitor (Step 1, page 76).

 Edit	Scroll to the Call to: line and press the display key.
	Delete the number.
either ...	Enter the external telephone number:
	Enter the new telephone number.
	Press the display key to open the menu.
Save Entry OK	Confirm. The entry is stored.
or ...	Enter the internal telephone number:
INT	Press the display key.
 OK	Select the handset and confirm.

Continue from Step 4 as described on page 76.

Changing an internal "call to" number

Precondition: You are in the entry field for the room monitor (Step 1, page 76).

 Edit	Scroll to the Call to: line and press the display key.
Yes	Press the display key to confirm the prompt.
Edit	Press the display key. The input field for the telephone number is opened.
either ...	Enter an internal number as the "call to" number:
INT	Press the display key.
 OK	Select the handset and confirm.
or ...	Enter an external number as the "call to" number:
	Enter the telephone number.
	Press the display key to open the menu.
Save Entry OK	Confirm. The entry is stored.

Continue from Step 4 as described on page 76.

Using several handsets

Deactivating the room monitor remotely

Take the call from the room monitor and key in **9 #**. The room monitor function will deactivate around 90 seconds after the call ends. The room monitor will make no further calls. The other room monitor functions on the handset (e.g. no ringer) will remain activated until you press the display key **Off** on the handset that is in the baby's room.

i

To reactivate the room monitor function with the same telephone number, you have to turn on the activation again and save with **Save**.

Setting the Walk and Talk mode

The Walk and Talk function allows two handsets to communicate with each other no matter how far they are from the base station.

Example: You go on holiday and take two handsets with Walk and Talk functionality with you. Set the Walk and Talk function **on both handsets**. You can now communicate using the handsets.

Precondition:

- ◆ Both handsets have been registered to the same base station **or**
- ◆ Both handsets are registered to different base stations and both are set to **Best Base** (page 70) **or**
- ◆ One of the handsets is not registered to any base station and the registered handset is set to **Best Base or**
- ◆ Neither handset is registered to a base station.



Please remember:

- ◆ The maximum range between handsets in Walk and Talk is 300 metres outdoors.
- ◆ The handsets cannot be reached by incoming calls.
- ◆ Walk and Talk mode severely reduces handset operating times.

Activating/deactivating the Walk and Talk mode

 → **Add. Features** → **Walk and Talk**







	Deactivating the Walk and Talk mode:
Off	Press the display key.

If you now press the talk key  or handsfree key , the call is sent to all handsets that are in Walk and Talk mode. The connection is made with the first handset to answer the Walk and Talk call.

<i>i</i>	<ul style="list-style-type: none"> ◆ The speaking volume and advisory tones are set in exactly the same way as if your handsets at home were in range of the base station (page 80 and page 82). Ringer tones cannot be set in Walk and Talk mode. ◆ "Activate/deactivate ringer" (page 83) and "Activate/deactivate keypad lock" (page 11) are available in the Walk and Talk mode. ◆ To open the menu, press display key . ◆ The Walk and Talk mode is retained even when you switch your handset off and back on.
----------	---

Using a handset in Walk and Talk mode as a room monitor

You can use a handset in Walk and Talk mode as a room monitor.

	Press the display key.
 Room Monitor 	Select the menu item and confirm.
 	Scroll to the Room M.: line and activate the room monitor.
 	You can scroll to the Level: line if you want to set the sensitivity for the noise level (Low or High).
Save	Press the display key. The room monitor function is now activated.

The room monitor will call all the handsets that are in the Walk and Talk mode.

	Always check the settings of the room monitor before you leave home, e.g. sensitivity and phone line.
---	--

Press the display key **Off** on the room monitor handset to deactivate the room monitor. The handset returns to the normal Walk and Talk mode.



Handset settings





Your handset is preset. You can change the settings to suit your requirements.

Changing the Display language

You can view the display texts in different languages.

 → **Settings**

 Language OK	Select the menu item and confirm. The current language is marked with ✓ (factory setting: English).
 OK	Select a language and confirm.
	Long press (back to idle status).

<i>i</i>	<ul style="list-style-type: none"> ◆ If you set the wrong language by mistake, press   . Now select the correct language with  and confirm your choice with OK. ◆ When you change the display language the character set can change too, e. g. for Russian.
----------	--

Activating/deactivating Auto Answer

If you have activated this function, when you get a call you can simply lift the handset out of its charger without having to press the talk key  (factory setting: On).





 → **Settings**

Auto Answer OK	Confirm to deactivate or activate the function (✓ = On).
	Long press (back to idle status).

Adjusting the loudspeaker volume

You can adjust the handsfree volume on five levels and the earpiece volume on three levels – you can even do this while an external call is in progress.



 → **Audio Settings**

Handset Volume OK	Confirm. You will hear the current handsfree speaking volume.
	Set the required level (1–5) in the entry field.
 	Scroll one line down and set the handset volume (1–3).
Save	Now press the display key to confirm the setting.
	Long press (back to idle status).

Ringer echo

You can select an echo effect for the long ringer melodies (4-10).

 → **Audio Settings**

Ringer Echo 	Confirm (✓ = On).
	Long press (back to idle status).

Changing the ringer



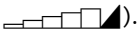





A range of options are available:

- ◆ Six volume levels:
 - Five volume levels (1–5; e.g. volume level 2 = )
 - "Crescendo" call (6; the volume increases with each ring = .
- ◆ Max. 26 melodies:
 - Max. 16 polyphone melodies (polyphone melodies have to have been saved with the Sound Manager, page 84)
 - Ten melodies (1–10; melodies 1–3 are the "classical ringer tones").





Settings for external calls, time control and name announcement

You can set the volume and melody to suit what is being signalled. You can also set the time control for the volume of a call (e.g. quieter during the night).

 → **Audio Settings** → **Ringer Settings**









	Setting the melody and volume:
Ext. Calls 	Confirm. You hear the current volume.
	Select the volume in the entry field.
 	Scroll to the next line and select the melody. You will hear the current melody and the name of the polyphone melody or number is displayed at the end of the line.
	Activating name announcement:
 	Scroll to the next line if necessary and activate/deactivate name announcement (page 27). The name will only be announced if the caller's number has been identified.
	Activating time control:
Time C.	Press the display key. <div style="border: 1px solid black; padding: 5px; display: inline-block;"> <p>Time ctrl: <input type="checkbox"/> On <input type="checkbox"/> Off</p> <p>From: 20:00</p> <p>Until: 08:00</p> <p> <input type="checkbox"/></p> <p>Save</p> </div> <div style="margin-left: 20px;"> <p>———— Status On or Off</p> <p>———— Period for "On"</p> <p>———— Ringer volume</p> </div>
	In the line Time ctrl : select On .

Handset settings

	Scroll to the From: line and enter the start of the period (4 -digit).
	Scroll to the Until: line and enter the end of the period (4 -digit).
	Scroll to the next line to set the volume for the ringer.
Save	Now press the display key to store the time control.
Save	Now press the display key to confirm the setting.
... then	
	Long press (back to idle status).



Individual settings for internal calls, wake-up and appointments



 → **Audio Settings** → **Ringer Settings**

either ...	For internal calls:
 Internal Calls OK	Select the menu item and confirm.
or ...	For appointments already set (page 16):
 Appointments OK	Select the menu item and confirm.
or ...	For a preset wake-up call (page 15):
 Alarm OK	Select the menu item and confirm.
or ...	To set all the functions the same:
 All OK	Select the menu item and confirm.
... then	
	Set the required level (1–5) in the entry field.
 	Scroll to the next line and select the melody. You will hear the current melody and the name of the poly-phone melody or number is displayed at the end of the line.
Save	Now press the display key to store the setting.
Yes	For the setting All , press the display key to confirm the prompt.
... then	
	Long press (back to idle status).

Activating/deactivating the ringer

All handsets ring when there is an incoming call. You can cancel the ringer on your handset before you answer a call or when the handset is in idle status; the ringer can be cancelled permanently or just for the current call.



	Cancelling the ringer permanently:
	Press the star key and hold until the ringer cannot be heard any longer. The ringer is now permanently cancelled. The  icon appears in the display.
	Re-activating the ringer:
	Press the star key and hold .

To cancel the ringer in the **idle status**, press the  key and hold until the  icon appears. The ringer cannot be re-activated while an external call is in progress.

i	To cancel the ringer for the current call, press the display key Silence .
----------	--

Activating/deactivating the alert tone

When you activate/deactivate the ringer you can activate an alert tone. When you get a call, you will hear **a short tone** (beep) instead of the ring tone.

	Press the star key and hold and within 3 seconds :
Beep on	Press the display key. Then an incoming call is signalled by a short alert tone . You will now see  in the display.
	Activating/deactivating the alert tone:
	Press the star key and hold . The ringer is switched on again.

Vibration alarm

Incoming calls and other messages are signalled with a vibration. This setting is independent of the ringer settings.











→ **Audio Settings**

Silent Alert	OK	Confirm (✓ = On).
		Long press (back to idle status).

Handset settings

Activating /deactivating suppression of the first ringer tone

The first ring is muted so that you are not disturbed by an incoming text message. You can change this setting so you can hear the first ring too.

	Open the menu.
   	Press keys.
either ...	You want to hear the first ring:
	Press the key.
or ...	You do not want to hear the first ring:
	Press the key.
	Confirm.







i	If you accept a call on the first ring and if this ring has signalled a text message, then the message will be lost.
----------	--

Sound Manager

You can use the Sound Manager to record polyphone melodies (maximum length 4 seconds) or transfer them with a data cable (max. 16 kb) (page 101). You can store up to 16 melodies.







Recording a melody

 → **Audio Settings** → **Sound Manager**

<New Sound> 	Confirm.
Record Sound? 	Confirm.
	Press the display key or wait 4 seconds, the recording is terminated. Your recording is played back automatically.
	Store the recording.
Edit Entry	Enter a name for the melody.
	Store the name.
	Long press (back to idle status).

Playing back the melody, editing the entry

 → **Audio Settings** → **Sound Manager**







	Select the melody.
either ...	Playing back the melody:
Play	Press the display key.
or ...	Changing an entry:
	Press the display key.
	Scroll to the Volume line to change the volume.
	Scroll to the Edit Entry line to change the name.
	Scroll to the View Entry line to view the file name.
	Scroll to the Delete Entry line to delete the entry.
... then	
	Long press (back to idle status).

Activating/deactivating advisory tones

Your handset uses "advisory tones" to tell you about different activities and statuses. The following advisory tones can be activated and deactivated individually (the factory setting: On).

- ◆ **Key click:** Every key press is confirmed
- ◆ **Acknowledge tones:**
 - Confirmation tone (rising tone sequence): at the end of an input/setting, when the handset is placed in the charging unit and when a new text message or a new entry arrives in the calls list or answering machine list (SL 150 only)
 - Error tone (a falling tone sequence): with incorrect input
 - End of menu tone: when scrolling at the end of a menu
- ◆ **Battery tone:** The battery needs recharging.

 → **Audio Settings** → **Advisory Tones**

	In the line Key Tones: activate or deactivate key click.
 	Scroll to the Confirm.: line to activate/deactivate acknowledge tones.
 	Scroll to the Battery: line and select On , Off or during call . The battery warning tone is then activated/deactivated or you will hear it only during a call.
Save	Now press the display key to confirm the setting.
	Long press (back to idle status).

Handset settings

Restoring the handset factory settings

You can reset individual settings and changes you have made. This will not affect entries in the directory, the calls list, the email directory or the speed dial list, the handset's registration to the base station and screensavers and melodies that you have loaded.

Press  to cancel the reset.

 → **Settings** → **Reset Handset**

Yes	Press the display key to confirm the prompt.
	Long press (back to idle status).

Factory settings of the handset

Base station selection	"Best Base station"	page 70
Earpiece volume	1	page 80
Handsfree volume	3	page 80
Ringer volume	5	page 81
Time control for ringer	deactivated	page 81
Ringer melody	Classic Ring	page 81
Name announcement	deactivated	page 27
Auto answer	activated	page 80
Battery tone/Key click/Confirmation tone	activated	page 85
Display language	English	page 80
Alarm clock/appointment	deactivated	page 15/ page 16
Appointment name	deleted	page 16
Screensaver	activated	page 51
Last number redial list	empty	page 28
Room monitor/room monitor sensitivity	deactivated/high	page 76

Setting the base station

All the settings for the base station are made with a registered SL 1 handset.





Protecting the telephone from unauthorised access

Protect the system settings of the base station with a system PIN that only you know. The system PIN now has to be entered for handset registration/de-registration, restoring factory settings, internal activation or barring numbers, for example.

Changing the System PIN

You can change the base station's 4-digit system PIN (factory setting 0000) to a 4-digit PIN which is known only to you. This also allows you to remotely operate the answering machine in the Gigaset SL 150 (page 64).

 → **Base Settings** → **System PIN**







 OK	If necessary, enter the current system PIN and confirm.
	Enter the new system PIN. For security reasons the input is shown as four asterisks (****).
 	Scroll to the next line and repeat the new system PIN.
OK	Confirm.
	Long press (back to idle status).

Assigning authorisation perhandset

You can prevent individual handsets from dialling external numbers.

You can assign the following authorisations

- ◆ **Internal and external:** The handset can be used without restriction.
- ◆ **Ext incoming:** The handset can be used to make internal calls. External calls can be accepted.
- ◆ **Internal only:** The handset can only be used for internal calls.

	Open the handset list.
 	Select the handset and open the menu.
 HS Call Barring OK	Select the menu item and confirm.
 OK	Enter the system PIN and confirm. (Factory setting: 0000).
 OK	Select the authorisation and confirm.
	Long press (back to idle status).

i	Emergency numbers can be dialled despite the authorisation restriction (page 88).
----------	---



Setting the base station

Emergency numbers

Emergency numbers are preset to local requirements. You can also save additional emergency numbers. The emergency numbers are valid for all handsets. Emergency numbers can still be dialled even if your handset is barred for external dialling.

Entering or changing an emergency number.



 → **Base Settings** → **Add. Features** → **Add. Emerg. No**

 OK	Enter the system PIN (factory setting: 0000) and confirm.
 >≡	Enter or change the emergency number and press the display key.
Save Entry OK	Confirm. The entry is stored.

i You can delete a stored emergency number with **<C**.

Displaying and dialling an emergency number

You can dial an emergency number from a handset that is barred for external dialling (page 87) (page 117) directly or as follows.

	The handset is barred for external dialling:
	Press the talk key
EmerCall	Press the display key. The available emergency numbers are displayed. If only one emergency number has been stored, this will be dialled immediately.
 OK	Select the emergency number and confirm. The connection is set up.

i

- ◆ If an access code has been set up (page 91), this will be placed in front of the emergency number automatically.
- ◆ When the keypad lock (page 11) is active, you cannot even call emergency numbers.

Changing the name of the base station

The names "Base station 1" to "Base station 4" are assigned automatically. You can change the name of your base station.

 → **Settings** → **Select Base**

Edit	Select the base station and press the display key.
	Enter a new name (up to 16 characters) (for text input see page 98).
Save	Now press the display key to confirm the setting.

<i>i</i>	The name of the base station is handset specific, i.e. the base station receives the name assigned to it from the corresponding handset. The same base station can have different names on different handsets.
----------	--

Repeater support

With a repeater you can increase the range and reception strength of your base station; the repeater has to be registered. To use the repeater you first have to activate the repeater mode. This will cancel any calls that are in progress.

 → **Base Settings** → **Add. Features**

 Repeater Mode OK	Select the menu item and confirm.
Yes	Press the display key to confirm the prompt.

Restoring the base station to factory settings

Resetting does not affect the system PIN and handsets are still registered.

 → **Base Settings** → **Base Reset**

 OK	Enter the system PIN (factory setting: 0000) and confirm.
Yes	Press the display key to confirm the prompt.

Setting the base station

Factory settings of the base station

Name of the handsets	"INT 1" to "INT 6"	page 71
Authorisation restriction of the handsets	Internal and external (none)	page 87
Internal listening in	deactivated	page 73
Network provider preselection	preset according to country	page 36
Own emergency numbers	deleted	page 88
Send centre	empty	page 35
SMS incoming and draft messages list	empty	page 44 and page 36
SMS message/message number.	deactivated/deleted	page 50/ page 50
List type	missed calls	page 33
Access code	none	page 91
pause after access code	3 s	page 92
Pause after recall key	800 ms	page 92
Pause after line seizure	3 s	page 92
Recall	250 ms	page 91
Dialling mode	DTMF	page 91

Answering machine functions (only S 150):		
Answering machine	activated	page 55
Messages on the answering machine	deleted	page 31
Number of mailboxes	one	page 55
Announcement	pre-recorded announcement	page 58
Personal announcement/Announce only	deleted	page 57
Voice prompts	deactivated	page 63
Recording time/quality	120 s/standard	page 66
Ring delay	after 20 s	page 66
Call Director	off	page 74
Call screening	activated	page 67

Connecting the base station to a PABX

The following settings are only needed when your PABX requires them, **please refer to the operating instructions for your PABX.**

i	You cannot send or receive text messages on PABXs that do not support Calling Line Identification.
----------	--

Dialling modes and and recall



The current setting is indicated by ✓.

1. Step 2: Changing the dialling mode

The following dialling modes can be set:



- ◆ Tone dialling (DTMF),
- ◆ Dial pulsing (DP).

 → **Base Settings** → **Add. Features** → **Dialling Mode**

 OK	Select and confirm a dialling mode (highlighted with ✓).
	Long press (back to idle status).

2. Step 2: Setting the recall



 → **Base Settings** → **Add. Features** → **Recall**

 OK	Select and confirm recall (highlighted with ✓).
	Long press (back to idle status).

Storing the access code (outside line code)

Precondition: Your PABX requires you to enter an access code before the telephone number when making an external call, e. g. "0".

 → **Base Settings** → **Add. Features** → **Access Code**

 	Enter or change the access code (maximum 3 digits) and press the display key.
Save Entry OK	Confirm. The entry is stored.
	Long press (back to idle status).

The access code will be automatically inserted before any of the numbers chosen from the calls /answering machine list.

Connecting the base station to a PABX

If you have stored an access code, the following will apply:

- ◆ For emergency numbers, SMS service centre numbers and dialling from the calls list or message list (SL 150 only) the access code is inserted **automatically**.
- ◆ For telephone numbers from the directory or network access list, you have to add the access code **yourself**.
- ◆ If you use the telephone number from the directory when sending an SMS, you have to delete the access code.
- ◆ You can delete an access code using . To insert a pause, press . **Insert Pause** or , **Insert Recall** .

Setting pauses

Changing the pause after line seizure

You can set the length of the pause that is inserted between pressing the top half of the key and the transmission of the telephone number (the factory setting is 3 seconds).

	Open the menu.
	Press keys.
	Enter a number for the length of the pause (1 = 1 sec.; 2 = 3 sec.; 3 = 7 sec. and confirm.

Change pause after Recall key

You can change the length of the pause if your PABX requires this (refer to the operating instructions for your PABX; the factory setting is 800 ms).

	Open the menu.
	Press keys.
	Enter a number for the length of the pause (1 = 800 ms; 2 = 1600 ms; 3 = 3200 ms) and confirm.

Changing the dialling pause (pause after access code)

Precondition: You have stored an access code (page 91). Factory setting: 3 seconds.

	Open the menu.
	Press keys.
	Enter a number for the length of the pause (1 = 1 sec.; 2 = 2 sec.; 3 = 3 sec.; 4 = 6 sec.) and confirm.

Switching temporarily to tone dialling (DTMF)

If your PABX still operates with dial pulsing (DP) but tone dialling (DTMF) is required for a particular call (e.g. to check your network mailbox), you have to switch to tone dialling during the call.

Precondition: A call is in progress.

	Open the menu.
Tone Dialing	Tone dialling is now activated for this call .

Appendix

Care

Wipe the base station and handset with a **damp** cloth (do not use solvents) or an anti-static cloth. **Never** use a dry cloth. This can cause static.

Contact with liquid



If the handset should come into contact with liquid, **on no account switch the device on. Remove the battery immediately.**

Allow the liquid to drain out of the device, and then pat all parts of the device dry.

Keep the handset with the battery removed in a warm, dry place for at least 72 hours. In many cases, you will then be able to use it again.

Questions and Answers

If you have any questions about the use of your phone, you can contact us 24/7 at www.my-siemens.com/customercare. You will find the most frequently asked questions and answers below.

What has happened if ...	Possible cause	Possible solution
... the display is blank?	The handset is not switched on. The battery is flat.	Press the "end call" key  for about 2 sec. Charge or replace the battery (page 10).
... the handset fails to respond to a key press?	The keypad lock is activated.	Press the hash key  for about 2 sec. to deactivate the lock (page 11).
... "Base station x" flashes in the display?	The handset is outside the range of the base station. The base station is not switched on.	Move the handset nearer to the base station. Check the power connector at the base station (page 8).
... Base Search flashes in the display?	The handset is set for Best Base . But no base station has been activated or in range.	Move the handset nearer to the base station. Check the power connector at the base station (page 8).
... the handset does not ring?	The ringer is switched off.	Activate/deactivate the ringer (page 83).
... I cannot hear a ringer tone/dial tone?	You have changed the telephone cord on your Gigaset.	When purchasing a new cord ensure that it has the correct pin connections (page 8).
... the call units/charges are not displayed?	There are no metering pulses.	Ask your network provider to transmit the metering pulses.
... the other party cannot hear me?	You have pressed the  (INT) key. This mutes the handset.	Switch on the microphone again (page 20).
... the incoming call number is not displayed even though CLIP is set?	Calling line identification is not enabled.	The caller should ask his network provider to enable the identification of his number (CLI).

Appendix

What has happened if ...	Possible cause	Possible solution
... I hear an error tone (falling tone sequence) when keying an input?	The action has failed or the input is incorrect.	Repeat the procedure; watch the display and if necessary refer to the operating instructions.
... I cannot listen to the network mailbox?	Your phone system is set for pulse dialling.	Set your phone system to tone dialling (page 92).
... the calls list does not indicate a time for a message?	Date/time are not set.	Set the date/time (page 15).
... the answering machine says "PIN is incorrect" during remote operation?	The entered system PIN is incorrect or still set to 0000.	Enter the system PIN again or set a PIN that is different from 0000 (page 87).
... the answering machine does not record any messages or has automatically switched over to "announce only"?	Its memory is full.	Delete old messages Play back new messages and delete.
... voice commands do not work?	You are too far away from the handset. The noise level in the room is too high.	The handset should be around 20 cm (8 inches) away from you. Record your voice pattern in quieter surroundings.

Service (Customer Care)

You can get assistance easily when you have technical questions or questions about how to use your device by using our online support service on the Internet at:

www.my-siemens.com/customer-care

or by referring to the section entitled **Questions and answers** in this manual (page 93).

If the device needs to be repaired, please contact one of our Customer Care Centers:

Abu Dhabi	0 26 42 38 00	Luxembourg	43 84 33 99
Argentina	0 80 08 88 98 78	Macedonia	02 13 14 84
Australia	18 00 62 24 14	Malaysia	03 21 63 11 18
Austria	05 17 07 50 04	Malta	00 35 32 14 94 06 32
Bahrain	40 42 34	Mauritius	2 11 62 13
Bangladesh	0 17 52 74 47	Mexico	01 80 07 11 00 03
Belgium	0 78 15 22 21	Morocco	22 66 92 09
Bosnia Herzegovina	0 33 27 66 49	Netherlands	0900-3333102
Brazil	0 80 07 07 12 48	New Zealand	08 00 27 43 63
Brunei	02 43 08 01	Norway	22 70 84 00
Bulgaria	02 73 94 88	Oman	79 10 12
Cambodia	12 80 05 00	Pakistan	02 15 66 22 00
Canada	1 88 87 77 02 11	Philippines	0 27 57 11 18
China	0 21 50 31 81 49	Poland	08 01 30 00 30
Croatia	0 16 10 53 81	Portugal	8 00 85 32 04
Czech Republic	02 33 03 27 27	Qatar	04 32 20 10
Denmark	35 25 86 00	Romania	02 12 04 60 00
Dubai	0 43 96 64 33	Russia	(800) 200 10 10
Egypt	0 23 33 41 11	Saudi Arabia	0 22 26 00 43
Estonia	06 30 47 97	Serbia	01 13 22 84 85
Finland	09 22 94 37 00	Singapore	62 27 11 18
France	01 56 38 42 00	Slovak Republic	02 59 68 22 66
Germany	01805 333 222	Slovenia	0 14 74 63 36
Greece	0 80 11 11 11 16	South Africa	08 60 10 11 57
Hong Kong	28 61 11 18	Spain	9 02 11 50 61
Hungary	06 14 71 24 44	Sweden	0 87 50 99 11
Iceland	5 11 30 00	Switzerland	08 48 21 20 00
India	01 13 73 85 89 - 98	Taiwan	02 25 18 65 04
Indonesia	0 21 46 82 60 81	Thailand	0 22 68 11 18
Ireland	18 50 77 72 77	Tunisia	0 71 86 19 02
Italy	02 66 76 44 00	Turkey	0 21 65 79 71 00
Ivory Coast	80 00 03 33	Ukraine	8 80 05 01 00 00
Jordan	0 64 39 86 42	United Arab Emirates	0 43 31 95 78
Kenya	2 72 37 17	United Kingdom	0 87 05 33 44 11
Kuwait	2 45 41 78	USA	1 88 87 77 02 11
Latvia	7 50 11 14	Vietnam	45 63 22 44
Lebanon	01 44 30 43		
Libya	02 13 50 28 82		
Lithuania	8 22 74 20 10		

Appendix

In some countries repair and replace services are impossible where the products are not sold through our authorised dealers.

Your Gigaset SL100 / SL150 is designed for operation in your country, as indicated on the packaging and on the device itself. Country-specific conditions have been taken into account. If you have any questions about the differences between the public phone networks, please contact your specialist dealer or network provider.

The CE mark attests to the phone's compliance with the essential requirements of the R&TTE directive.

Excerpt from the original declaration:

"We, Siemens AG, declare that the above mentioned product is manufactured according to our Full Quality Assurance System certified by CETECOM ICT Services GmbH in compliance with ANNEX V of R&TTE Directive 99/05/EC. The presumption of conformity with the essential requirements regarding Council Directive 99/05/EC is ensured."

Senior Approvals Manager

The Declaration of Conformity (DoC) has been signed. If necessary, a copy of the original DoC can be made available via the company hotline.

CE 0682

Specifications

Recommended battery

Lithium-Ion (Lilon), 700 mAh

(Valid when these operating instructions were printed)

The device is supplied only with a recommended battery.

Handset operating times/charging times

Capacity (mAh)	Standby time (hours)	Calling time (hours)	Charging time (hours)
700	min. 250 (10 days)	approx. 15	approx. 2.5

These operating and charging times apply only when using the recommended battery.

Power consumption

- ◆ In idle status: SL 100 approx. 1.6 Watt and SL 150 approx. 2.2 Watt.
- ◆ During the call: SL 100 approx. 2.0Watt and SL 150 approx. 2.5 Watt.

General Specifications



Feature	Value
DECT standard	is supported
GAP standard	is supported
No. of channels	60 duplex channels
Radio frequency range	1880–1900 MHz
Duplex method	Time multiplex, 10 ms frame length
Channel grid	1728 kHz
Bit rate	1152 kbit/s
Modulation	GFSK
Language code	32 kbit/s
Transmission power	10 mW, average power per channel
Range	up to 300 m outdoors, up to 50 m indoors
Power supply/Base station	230 V ~ / 50 Hz
Environmental conditions for operation	+5 °C to +45 °C; 20 % to 75 % humidity
Dialling mode	DTMF (tone dialling)/DP (dial pulsing)
Recall	250 ms
Dimensions/Base station	Gigaset SL 100/SL 150: 143 x 118 x 50 mm (L x W x H)
Dimensions/Handset	114 x 47 x 22 mm (L x W x H)
Weight	Base station SL 100: 167 g and Base station SL 150: 174 g; handset with battery cell: 81 g

Answering machine remote operation (SL 150 only)

The functions of the keys used to operate the answering machine remotely are the same for all telephones, handsets and tone transmitters. The "credit card" shows you how to perform remote operations on an external telephone (e.g. from a pay phone, from a hotel etc.) and the meaning of the keys.

To begin:

 Dial your own telephone number. You hear your answering machine.

 **9** +  Press key and enter the system PIN. Control the answering machine with the digit keys

Activate the answering machine: Allow phone to ring for about 1 min.













 Enter system PIN. The answering machine activates itself.

1	2	3
Pre- vious	Stop/ Cont.	Next
4	5	6
7	8	9
		Voice prompts
*	0	#
new	Clearing the mail- box	Changing the mail- box

Character set chart





Standard characters

Press the relevant key repeatedly or hold it down

	1 x	2 x	3 x	4 x	5 x	6 x	7 x	8 x	9 x	10 x	11 x	12 x	13 x	14 x
	Space	1	€	£	\$	¥	¤							
	a	b	c	2	ä	á	à	â	ã	ç				
	d	e	f	3	ë	é	è	ê						
	g	h	i	4	ï	í	ì	î						
	j	k	l	5										
	m	n	o	6	ö	ñ	ó	ò	ô	õ				
	p	q	r	s	7	ß								
	t	u	v	8	ü	ú	ù	û						
	w	x	y	z	9	ÿ	ý	æ	ø	å				
	.	,	?	!	0	+	-	:	;	;	"	"	;	_
	abc-> 123	123-> abc	*	/	()	<	=	>	%				
	#	@	\	&	§									

Writing and editing text (without predictive text)

You can write and edit text in a number of ways:

- ◆ The cursor is controlled with .
- ◆ Characters (to the left of the cursor) are deleted with .
- ◆ Characters are added to the left of the cursor (page 13).
- ◆ To switch from upper case (first letter upper case, all other letters lower case) to digits, press  before you press key in the letter. Pressing  again switches from digits to lower case letters. Press again to switch from lower case to upper case letters.
- ◆ The first letter of the name of directory entries is automatically capitalised, followed by lower case letters.
- ◆ When you press a key **and hold it**, the characters of that key appear in the **bottom display line** and are highlighted one after the other. When you release the key the highlighted character is inserted into the input field.

You can see in the display whether upper case, lower case or digits are selected:

- "A" or "a" appears on the bottom display line when you make an entry in the directory.
- When entering a text message you will see "Abc", "abc" or "123" in the top right of the display.

Order of directory entries

The directory entries are normally sorted alphabetically, but spaces and digits have higher priority. The **sorting order** is:

1. Space (shown here as )
2. Digits (0–9)
3. Letters (alphabetical)
4. Other characters



To work around the alphabetical order of the entries in the directory, insert a space before the name. This entry then goes to the first position (example: "Carla"). You can also number the entries with digits (e.g. "1Jane", "2Mary", "3John").

Names preceded with a star (e.g. "*Ute") are placed at the end of the directory.

Predictive text

The EATONI predictive text helps you to write:

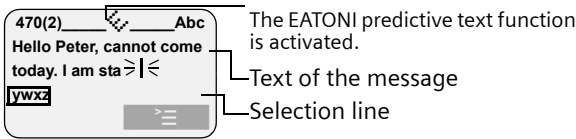

- ◆ SMS
- ◆ Names in the directory,
- ◆ Names in the speed dial list,
- ◆ Names in the email.

Each key between  and  is assigned **several letters and characters** which all appear on a **selection line** (above the display icons) as soon as you press a key. When you are entering letters, the letter you are **most probably** looking for is **reverse highlighted**. This letter is at the beginning of the selection line and is transferred to the text area.



If this letter is the one you want, confirm it by pressing the next key. If the letter selected by the EATONI is not the one you want, then press the **hash key**  repeatedly until the required letter appears reverse highlighted in the display line and is transferred to the text area.





Key functions with activated predictive text

	Short press of star key: Switches from "abc" to "Abc" mode, from "Abc" to "123" and from "123" to "abc".
	Goes to the next letter in the selection list (reverse highlighted).

Activating/deactivating predictive text

Predictive text is activated and deactivated according to specific functions. Even if you have deactivated predictive text when entering a name in the telephone for instance, it is still available for writing text messages.

Precondition: You are in a text input field (SMS, name in the directory, speed dial list or email directory).

	Open the menu.
 Predictive Text 	Select the menu item and confirm (✓ = On).
	Press the "end call" key briefly to return to the text area. Now enter your text.

PC Interface

You can connect your SL 1 handset to a computer using a Siemens data cable (page 104). Your computer can then communicate with your SL 1 using "Siemens Data Suite" (free download available at <http://www.my-siemens.com/gigaset-sds>) and access the following parameters and lists in the handset:

Reading out parameters

- ◆ SW version
- ◆ Type
- ◆ Manufacturer's code

Read/write access to:

- ◆ the directory
- ◆ the email directory
- ◆ the network access list
- ◆ the appointments list
- ◆ the last number redial list

Read/write access to other parameters:

- ◆ ringer settings
- ◆ volume settings
- ◆ loading screensavers
- ◆ loading melodies
- ◆ accepting calls and talking on the phone

Data transfer

Some functions involve the transfer of large volumes of data between the handset and the external device. In this case the handset switches to data transfer mode, **Data Transfer** appears in the display. In this mode, you cannot make any entries via the keypad and incoming calls are ignored.

In the following situations, the handset switches to data transfer mode:

- ◆ Read/write access to the directory
- ◆ Read/write access to the email directory
- ◆ Read/write access to the network access list
- ◆ Read/write access to the the appointments list
- ◆ Read/write access to the last number redial list
- ◆ Loading screensavers
- ◆ Loading melodies

If an error occurs during transfer, the handset automatically switches to idle status.



Making and accepting calls

If you dial a number from an external device or accept a call from one, the handset will respond as if you had executed this function on the handset.

"Balloon Shooter" Game

Try to hit as many balloons as you can.

 → **Add. Features** → **Balloon Shooter**

either ...	Starting the game:
	Press the display key.
or ...	Other options:
	Press the display key to open the options menu.

To move the sights press:

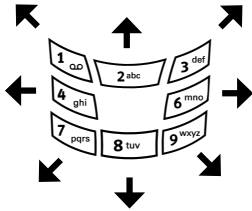

or

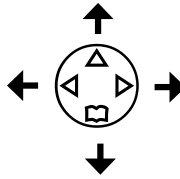

To shoot the balloon, press  .

Accessories

Gigaset Handsets

Turning your Gigaset into a cordless telephone system:



Gigaset Handset SL 1

- ◆ Large illuminated graphic display with date and time
- ◆ Directory for about 200 entries
- ◆ Full duplex grade handsfree
- ◆ SMS (precondition: you have CLIP and SL 100/SL 150 is SMS enabled)
- ◆ EATONI predictive text
- ◆ Transferring/managing directory, Outlook appointments etc via PC interface
- ◆ Caller-based ringer melody setting (for VIP calls)
- ◆ Melodies can be downloaded by SMS
- ◆ Polyphone call tone melodies (16-chord)
- ◆ Recording call tone melodies via the handset
- ◆ Room monitor
- ◆ Walk and Talk
- ◆ Voice selection for 29 names
- ◆ Announce name when calling
- ◆ Balloon Shooter game preinstalled
- ◆ Vibration alarm



Gigaset Handset S 1

- ◆ Large illuminated graphic display with date and time
- ◆ Directory for about 200 entries
- ◆ Full duplex grade handsfree
- ◆ SMS (precondition: you have CLIP)
- ◆ EATONI predictive text
- ◆ Caller-based ringer melody setting (for VIP calls)
- ◆ Melodies can be downloaded by SMS
- ◆ Room monitor
- ◆ Walk and Talk
- ◆ Voice selection for 29 names
- ◆ Announce name when calling



Gigaset Handset C 2

- ◆ Graphic display with date and time
- ◆ Directory for about 100 entries
- ◆ Handsfree
- ◆ SMS (precondition: you have CLIP)
- ◆ EATONI predictive text
- ◆ Caller-based ringer melody setting (for VIP calls)
- ◆ Room monitor
- ◆ Walk and Talk



Gigaset Handset C 1

- ◆ Graphic display with date and time
- ◆ Directory for about 50 entries
- ◆ Handsfree
- ◆ SMS (precondition: you have CLIP)

Data Cable DCA-500

To connect the telephone to your computer's RS232 serial interface.

MP Accessory

You can also use the S55 handset's MP Accessories.

◆ Carrying cord

You can use the carrying cord to carry the handset or hang it around your neck.

- ◆ **HHS-510 Mobile Handsfree Set** (Order No. L36880-N5601-A108) with PTT (Push To Talk) button. You can use the mobile handsfree set to telephone without using your hands.

- ◆ **EDC-510 charger unit** (Best.-Nr. L36880-N5601-A101)

You can use the charger unit to recharge the telephone and an additional battery.





All accessories and batteries are available from your mobile phone retailer. Or you can order direct online from the my-siemens Online Shop: www.my-siemens.com/shop . The Online Shop also has the latest product information.



Only use original accessories. This will avoid possible health risks and damage, and also ensure that all the relevant regulations are complied with.

Menu Tree

Instead of scrolling to locate a menu function, you can select a menu function faster by opening the menu and keying in the digit combination ("shortcut").

Example:     for "set ringer melody for the alarm clock".

Main menu

With the telephone in the **idle status**, press  (open menu):





You have activated an SMS mailbox (Allg. oder Privat) without PIN				
1	SMS	1-1	Write Message	
	or ...	1-2	Incoming 00+00	
		1-3	Outgoing	
You have activated an SMS mailbox oder 2-4 Mailboxen with a PIN				
1	SMS	1-1	Mailbox	1-1-1 Write Message
				1-1-2 Incoming 00+00
				1-1-3 Outgoing
		1-2 bis	Mailbox 1	1-2-1 Write Message
		1-4	Mailbox 2	1-4-1
			Mailbox 3	1-2-2 Incoming 00+00
				1-4-2
				1-2-3 Outgoing
				1-4-3
3	Add. Features	3-1	Room Monitor	
		3-2	Walk and Talk	
		3-3	Balloon Shooter	
4	Calendar/ Clock	4-1	Set Appoints.	
		4-2	Alarm Clock	
		4-3	Missed Dates	
		4-4	Date/Time	
5	Audio Settings	5-1	Handset Volume	
		5-2	Ringer Settings	5-2-1 Ext. Calls
				5-2-2 Internal Calls
				5-2-3 Appointments
				5-2-4 Alarm
				5-2-5 All
		5-3	Sound Manager	
		5-4	Advisory Tones	
		5-5	Ringer Echo	
		5-6	Silent Alert	



7	H/Set Settings	7-1	Auto Answer				
		7-2	Language				
		7-3	Register H/Set	(List)			
		7-4	Select Base	7-4-1	Base 1		
				7-4-...	[to]		
				7-4-4	Base 4		
				7-4-5	Best Base		
		7-5	Screen Picture				
		7-6	Reset Handset				
8	Base Settings	8-2	System PIN				
		8-3	Base Reset				
		8-4	Add. Features	8-4-1	Dialling Mode	8-4-1-1	Tone
						8-4-1-2	Pulse
				8-4-2	Recall	8-4-2-1	80 ms
						8-4-2-...	[to]
						8-4-2-8	800 ms
				8-4-3	Repeater Mode		
				8-4-4	Access Code		
				8-4-5	Add. Emerg. No		
				8-4-6	Listening In		
				8-5	Preselection	8-5-1	Preselect. No.
						8-5-2	With Preselect
						8-5-3	Without Presel.
		8-6	Call Director (SL 150 only)	8-6-1	Call Director		
				8-6-2	Rec Announce		
				8-6-3	Play Announce		
				8-6-4	Del Announce		

Menu Tree

9	Answer Machine	9-1	Set Key 1	9-1-1	Network Mailb.		
	SL 150 only:			9-1-2	Answer Machine		
		9-2	Ans Machine				
		9-3	Call Screening	9-3-1	Handset		
		9-4	Record Memo				
		9-5	Announcements	9-5-1	Rec Announce		
				9-5-2	Play Announce		
				9-5-3	Del Announce		
				9-5-4	Rec Anc Only		
				9-5-5	Play Anc Only		
				9-5-6	Del Anc Only		
				9-5-7	Set Ans. Mode	9-5-7-1	Ans. & Record
						9-5-7-2	Announce Only
						9-5-7-3	Ans Mode Time
		9-6	Message Set	9-6-1	Message Length		
				9-6-2	Record Quality		
		9-7	Ring Delay				
		9-8	Voice Prompts	9-8-1	Record Command	9-8-1-1	User 1
						9-8-1-...	[to]
						9-8-1-4	User 4
				9-8-2	Commands		

Directory key and speed dial list key

Press the directory key  or the speed dial list key , select an entry with  and press  to open the required list. The following **menu functions** are available:

Display Number	
Edit Entry	
Delete Entry	
VIP Entry	For the directory only ()
Copy and Edit	For the directory only ()
Copy Entry	
Delete List	
Copy List	
Available Memory	

Calls List/Answering Machine List (SL 150 only)

Press . You will now see the following lists:

SMS: 00-00		
Ans M.: 00+00 (SL 150 only)	or	Mailbox 1 00+00
		Mailbox 2 00+00
		Mailbox 3 00+00
Mailbox: 00+**		
Calls List: 00+00		
Mark as new		

Index

A

- Accept
 - call 18
 - Accept Call Director 75
 - Access code
 - for a PAXB 91
 - pause 92
 - Access protection 87
 - Acknowledge tones 85
 - Activate
 - advisory tones 85
 - alarm clock 15
 - Answering machine 55
 - answering machine 55, 56
 - answering machine via remote
 - operation 65
 - appointment 16
 - Call Director (SL 150 only) 74
 - Handset 11
 - internal listening in 73
 - predictive text 100
 - Ring delay 80
 - ringer suppression 84
 - room monitor 76
 - two way recording 63
 - Voice prompts 64
 - Walk and Talk mode 79
 - Activate/deactivate 80
 - Activating/deactivating advisory tones 85
 - Adjusting the loudspeaker volume . . . 80
 - Alarm
 - vibration alarm 83
 - Alarm clock
 - activating the 15
 - deactivate 16
 - settings 15
 - Alert tone 83
 - Anniversary
 - enter 26
 - not kept 17
 - Announce (SL 150 only)
 - deleting for Call Director 74
 - personal announcement 55
 - playing for Call Director 74, 75
 - playing/deleting for ans. m. 57
 - recording for Call Director 74
 - Announce only (answering machine) . 55
 - Announcement
 - recording 57
 - selecting for answering machine . . . 58
 - Announcement mode, see Answering machine
 - Answering machine 55
 - announcement mode 55
 - memos 55
 - messages 55
 - operating with the handset 55
 - Answering machine (SL 150 only)
 - activate/deactivate (handset) . . 55, 56
 - announcement 57
 - announcement mode 58
 - delete message 61
 - picking up a call 62
 - record memo 62
 - recording quality 66
 - remote operation 64
 - set Key 1 67
 - set ring delay 66
 - settings 66
 - skip forward/back 61
 - two way recording 63
 - voice prompts 64
 - Answering machine list 31, 33
 - Answering machine see Network mailbox
 - Appointment
 - activate/set 16
 - cancelling 17
 - deactivate 17
 - name 16
 - not kept 17
 - setting ringer 82
 - Area code 40
 - Area prefix, see area code
 - Attachment see SMS
 - Authorisation
 - handset 87
 - Auto answer 80
- ## B
- Balloon Shooter 102
 - Barging in (joining a call) 73

Index

Base station		
change	70	
changing the name of the base station	89	
connecting the base station	8	
connecting to a PABX	91	
preparing to use	7	
restore factory settings	89	
setting up a	7	
settings	87	
Battery		
charging	10	
display	10	
inserting	9	
Recommended batteries	97	
Battery tone	85	
Block		
external dialling	87	
Handset	87	
internal dialling	87	
Blocking external dialling	87	
Blocking internal dialling	87	
C		
Call		
accepting a	18	
ending	18, 71	
picking up a call from the answering machine	62	
transfer (connect)	71	
two way record	63	
Call Director	74	
Call Director (SL 150 only)		
activate/deactivate	74	
pick up a call	75	
play/delete announcement	74, 75	
Record announcement	74	
Call screening during recording	67	
Call waiting		
internal call	73	
Call-by-Call numbers	21	
Calling back a caller	34	
Calling back from calls list	34	
Calling Line Identification	18	
Calls list	31	
delete a single entry	34	
opening the	33	
settings	33	
Cancel (operation)	13	
Care of the telephone	93	
Carrying clip	11	
Change		
"call to" number	77	
a handset's internal number	72	
base station name	89	
Dialling mode	91	
dialling mode	91	
Display language	80	
Emergency numbers	88	
handsfree volume	20	
loudspeaker volume	80	
name of a handset	71	
pauses	92	
ringer	81	
system PIN	87	
Changing	64	
Changing the language (display)	80	
Changing the System PIN	87	
Character set (SMS)	38	
Character set chart	98	
Charge saving function	66	
Charging status display	10	
CLI	18	
CLIP	18	
CNIP	18	
Confirmation tone	13, 85	
Connecting		
base station to a PABX	91	
Control key	12	
Copy number to directory (SMS)	46	
Correcting wrong input	13	
Cursor s. Schreibmarke		
Customer Care (Service)	95	
Customer service	95	
D		
Date and time	15	
Date setting	15	
Deactivate		
advisory tones	85	
alarm clock	16	
Answering machine	55	
answering machine	55	
answering machine (SL 150 only)	55	
answering machine (SL 150 only)	55, 56	
appointment	17	
appointment call	17	

- Call Director (SL 150 only) 74
- Handset 11
- internal listening in 73
- predictive text 100
- Ring delay 80
- ringer (handset) 83
- ringer suppression 84
- two way recording 63
- wake-up call 16
- Walk and Talk mode 79
- Delete
 - Anniversary 17
 - announcement for ans. m.
(SL 150 only) 57
 - announcement for Call Director
(only SL 150) 74, 75
 - appointment 17
 - character 13
 - message 61
 - SMS entry 42
 - SMS list 42, 45
 - voice patterns 27
- Delete key 13
- De-registering a handset 70
- Dial pulsing 91
- Dialling
 - an emergency number 88
 - cancelling 18
- Dialling mode 91
 - changing a 91
- Dialling pause 18, 92
- Directory 21
 - opening the 12
 - order of entries 99
 - send an entry to a handset 24
 - storing a number 22
 - use to input telephone number 25
- Display
 - 12/24 hour display 15
 - anniversaries not kept 17
 - appointments not kept 17
 - Calling the network mailbox 68
 - changing language 80
 - Changing the display language 80
 - display keys 12
 - Emergency numbers 88
 - in idle status 14
 - memory 30
 - name (CNIP) 18
 - number (CLI/CLIP) 18
 - removing protective film 9
- DP (dial pulsing) 91
- Draft message list (SMS) 38, 39, 41
- E
 - Earpiece mode 1, 20
 - EATONI (predictive text) 100
 - Einstellungen s. Einstellen
 - Email address see SMS 40
 - Email directory 29
 - Email service (number) 37
 - Emergency numbers 88
 - changing 88
 - dialling 88
 - displaying 88
 - entering 88
- End
 - Call 18
- End call key 1, 18
- Enquiry call
 - internal 72
- Enter
 - birthday/anniversary 26
- Enter birthday (as appointment) 26
- Entering
 - an emergency number 88
- Entry (directory)
 - find and dial 23
- Entry language (SMS) 38
- Error messages, see SMS
- Error tone 13, 85
- Escape key 13
- Exit
 - internal call 71
- F
 - Factory settings
 - base station 89
 - handset 86
 - Fast access 68
 - Network mailbox 68
 - set Key 1 1
 - Forward 45
- G
 - Group call 71

Index

H

- Handset
 - activate/deactivate 11
 - activating the 11
 - Authorisation 87
 - belt clip 11
 - blocking 87
 - change for best reception 70
 - change to another base station 70
 - changing an internal number 72
 - deactivate 11
 - de-register 69, 70
 - direct calling (Call Director) 74
 - list 12
 - muting 20
 - operating and charging times 97
 - paging 70
 - preparing to use 9
 - register 69
 - register on another base station 70
 - restore factory settings 86
 - settings (individual) 80
 - transferring a call 72
 - use as room monitor 75
 - using in Walk and Talk mode as a room monitor 79
- Handset charging times 97
 - Handset operating time
 - in room monitor mode 76
 - in Walk and Talk mode 78
 - Handset volume 80
 - Handsfree 20
 - changing the volume 20
 - key 1
 - Hash key 1, 11
 - Hearing aids 6

I

- Icon
 - for new messages 60, 61
- Idle status (display) 14
- Incoming message list (SMS) 38, 43, 44, 51
- opening the 44
- Internal
 - consultation 72
 - listen in 73
 - making calls 71

K

- Key 1 (fast access) 1, 67
- Keys
 - Activating/deactivating keypad protection 11
 - cancel 13
 - control key 12
 - delete key 13
 - display keys 12
 - escape 13
 - hanging up 18
 - Key click 85
 - key press (confirmation tone) 85
 - last number redial key 13
 - menu key 13
 - OK key 13
 - talk key 18

L

- Last number redial
 - key 13
 - manually 28
- Last number redial list 28
- List
 - answering machine list 31
 - calls list 31
 - delete (SMS) 42, 45
 - draft message list (SMS) 39
 - email directory 29
 - handsets 12
 - incoming message list (SMS) 44, 51
 - missed calls 32
- Lock
 - Activating/deactivating keypad protection 11
- Loudspeaker volume 80

M

- Mailbox ID, see SMS
- Mailboxes, see SMS
- Making calls
 - answering a call 18, 19, 20
 - external 18
 - internal 71
 - internal call 71
 - making an external call 18
- Manual last number redial 28
- Medical appliances 6

- Melody
 polyphone 81, 84
Melody (ringer) 81
Memory 30
Memos, see Answering Machine
Menu
 back one menu level 13
 end tone 85
 key 13
 menu guidance 12
 opening the 12
 tree 106
Message
 clearing the 61
 icon for new 60
 play 60
Message key
 open list 44
Message, see Answering Machine
Messages
 Icon 61
 key 1
Microphone 1
Missed call 32
Move cursor 12
Muting the handset 20
- N**
Name
 changing the name of the base
 station 89
 display caller's (CNIP) 18
 of a handset 71
Network mailbox
 configuring for fast access 68
 viewing message 68
Network provider (numbers list) 21
Not kept
 anniversary 17
 appointment 17
Notes (spoken) see Memo 55
Notification, see SMS
Notify number see SMS
Notify type see SMS
Number, see telephone number
 or entry 22
- O**
OK key 13
On/Off key 1
Open
 directory 12
 menu 12
Operating time
 of the handset 97
Operation (preparing to use your
 phone) 7
Order in directory 99
- P**
PABX 91
 pause after access code 92
 set dialling mode 91
 set recall 91
 Setting pauses 92
 Storing an access code 91
 switch to tone dialling 92
Pack contents 7
Paging 70
Paging key 70
Pause
 after access code 92
 after Recall key 92
 change after line seizure 92
Pauses for a PABX 92
PC Interface 101
Phone cord 8
Phone jack 8
PIN
 SMS PIN 48
Playing
 voice patterns 27
Playing (SL 150 only)
 announcement for ans. m. 57
 announcement for Call Director. 74, 75
 messages (answering machine) 60
Polyphone melodies 81, 84
Power cord 8
Power supply unit 6, 8
Precondition
 sending and receiving SMS 36
Predictive text 39, 40, 100
 activate/deactivate 100
Prefix, see area code

Index

Preparing the telephone		
handset	9	
Telephone	7	
Pre-recorded announcement (answering machine)	55	
Protect telephone from access	87	
Provider	35	
Q		
Questions and answers	93	
R		
Range	7	
Recall	91	
Recall key	1	
pause after	92	
Receive (SMS)	43	
Record (SL 150 only)	55	
Record memo	62	
Record voice command	63	
Recording		
announcement for ans. m.	57	
memo (SL 150 only)	62	
two way recording	63	
voice commands	63	
voice patterns	26	
Recording (SL 150 only)		
announcement for Call Director	74	
Recording quality	66	
Registering handsets	69	
Reminder call	25	
Remote operation		
activating	65	
answering machine	64	
Remove protective film (display)	9	
Repeater	89	
Reset, see Factory settings		
Ring delay	66	
Ringer		
activating the	83	
changing a	81	
deactivating the	83	
melody settings	81	
set volume	81	
suppress	35	
suppressing	84	
time control for volume	81	
Ringer echo	81	
Ringer tone, see SMS		
Room monitor	75	
activating the	76	
Setting the sensitivity	79	
setting the sensitivity	76	
using in Walk and Talk mode	79	
S		
Safety precautions	6	
Saving		
access code for a PAXB	91	
directory entry	22	
SMS	39	
Screensaver, see SMS		
Select menu option	12	
Select option (menu)	12	
Send		
directory entry to a handset	24	
SMS	39, 42	
Service	95	
Service Provider	35	
Setting		
alarm clock	15	
answering machine	66	
appointment	16	
Base station	87	
date	15	
Display language	80	
external calls	81	
handset (individual)	80	
handset volume	80	
loudspeaker volume	80	
melody	81	
Name announcement	81	
pauses	92	
recall	91	
Ring delay	66	
ringer (melody)	81	
ringer volume	81	
room monitor function	76	
time	15	
Time control	81	
time control	81	
volume	81	
Walk and Talk mode	78	
Setting name announcement	81	
Setting sensitivity in room monitor		
mode	76, 79	
Short Message Service, see SMS		
Shortcut	106	

- Signal strength 7
 - Signal tone, see Advisory tones
 - Skip back (ans. m.) 61
 - Skip forward (answering machine) . . . 61
 - SMS 35
 - activate/deactivate mailbox 48
 - activating/deactivating a
 - screensaver 52
 - activating/deactivating the function 36
 - assigning a PIN 48
 - change mailbox 49
 - Character set 38
 - copying number to directory 46
 - delete list 42, 45
 - editing/returning 45
 - Entering an email address 40
 - entry language 38
 - errors in reception/transmission . . . 53
 - forward 45
 - Insert picture 42
 - Insert sounds 42
 - loading a ringer tone 51
 - loading a screensaver 51
 - mailbox ID 48, 49
 - mailboxes 47
 - mark as new 47
 - notification by SMS 50
 - notify number 50
 - notify type 50
 - opening an attachment
 - Predictive text 39
 - reading/deleting 42
 - receiving 43
 - reply to 45
 - Ringer suppression 35
 - saving the 39
 - Selecting an email address 42
 - self-help with error messages 54
 - send 39
 - send centre 37
 - sending and receiving 36
 - sending as email 35, 40
 - sending/editing 42
 - setting to a personal mailbox 49
 - SMS centres 35
 - Storage capacity 35
 - Templates 42
 - to a PABX 52
 - SMS centre 35
 - changing a number 37
 - Sound Manager 84
 - Special functions 73, 88, 89, 91
 - Specifications 97
 - Speed dial key 21
 - Speed dial list 21
 - changing a single entry 23
 - store a number 22
 - Speed dial list key 1
 - Star key 1, 83
 - Storage capacity see SMS
 - Store entry (network mailbox) 68
 - Suppressing
 - first ring 35
 - Switch off, see Deactivate
 - System settings 87
- T**
- Talk key 1, 18
 - Telephone
 - operating the 12
 - Telephone number
 - enter number of network mailbox . . 68
 - input from directory 25
 - pick from directory 25
 - saving the 22
 - showing caller's (CNIP) 18
 - Storing an SMS in the directory . . . 45
 - Templates see SMS
 - Text field (empty), see SMS
 - Text message, see SMS 35
 - Time control
 - ringer volume 81
 - settings 81
 - Time setting 15
 - Tone
 - confirmation 13, 85
 - error tone 13, 85
 - Tone dialling 92
 - Two way record 63

Index

V

- Vibration alarm 83
- Viewing a message from the network mailbox 68
- Voice patterns
 - clearing the 27
 - playing 27
 - recording 26
- Voice prompts 63, 64
- Voice-activated dialling 12, 26
 - dial 26
- Volume
 - handset volume 80
 - loudspeaker volume 80
 - ringer volume 81
 - settings 81

W

- Wait melody 20
- Wake-up call
 - deactivate 16
 - setting ringer 82
- Walk and Talk mode 79
 - activating the 79
 - deactivate 79
 - settings 78
 - using a handset as a room monitor . 79
- Warning tone, see advisory tones
- Writing a text message 38
- Wrong input (correcting) 13